

GIXSW 12 FLURO

TYPE: Plain bearings, Spherical plain bearings and rod ends, Rod ends, Maintenance free, With internal thread, open design, right hand thread, series GIXSW (FLURO)

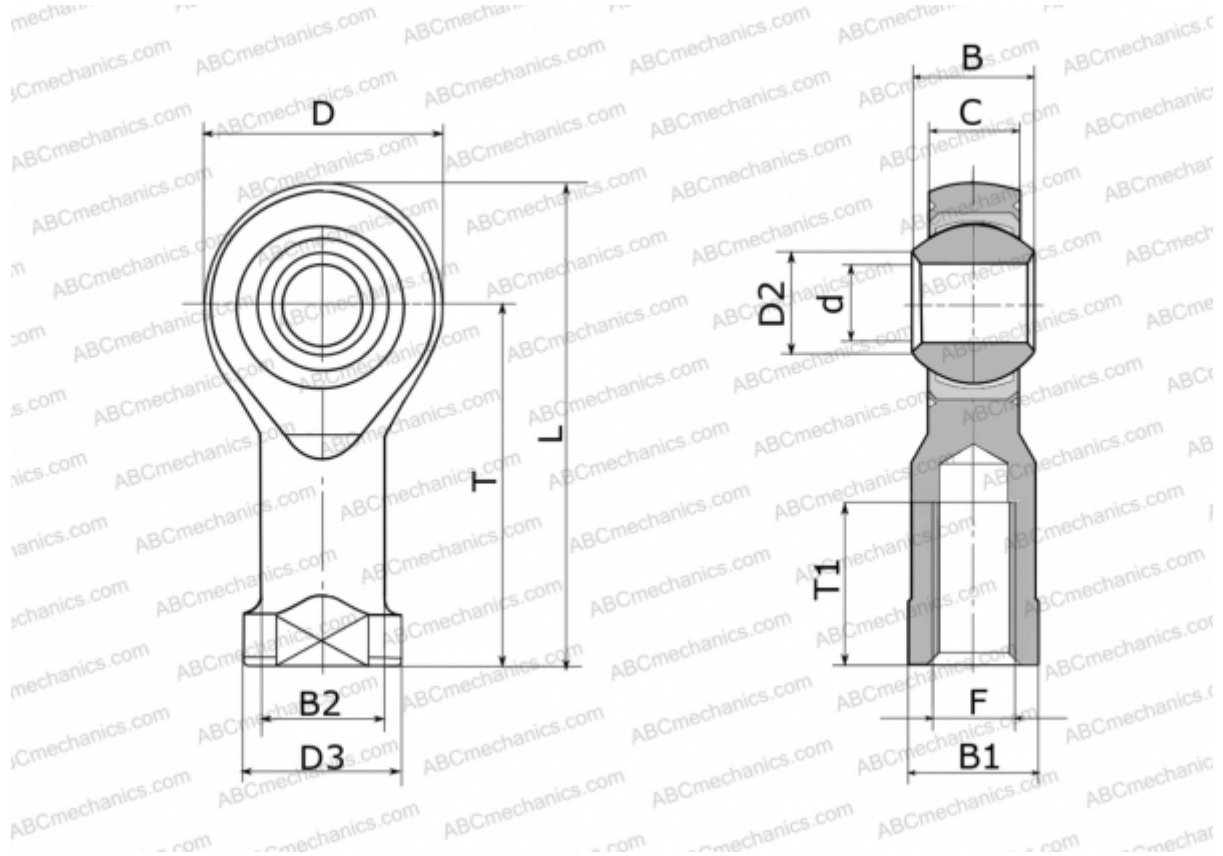

Technical specification

DIMENSIONS, MM

d	12,000
D	32,000
D2	15,400
D3	22,000
B	16,000
B1	19,000
B2	17,500
L	66,000
T	50,000
T1	22,000
C	12,000
F	M 12

MANUFACTURER

[FLURO](#)

WEIGHT, KG

0,115