

GIXSW 40 FLURO

TYPE: Plain bearings, Spherical plain bearings and rod ends, Rod ends, Maintenance free, With internal thread, open design, right hand thread, series GIXSW (FLURO)

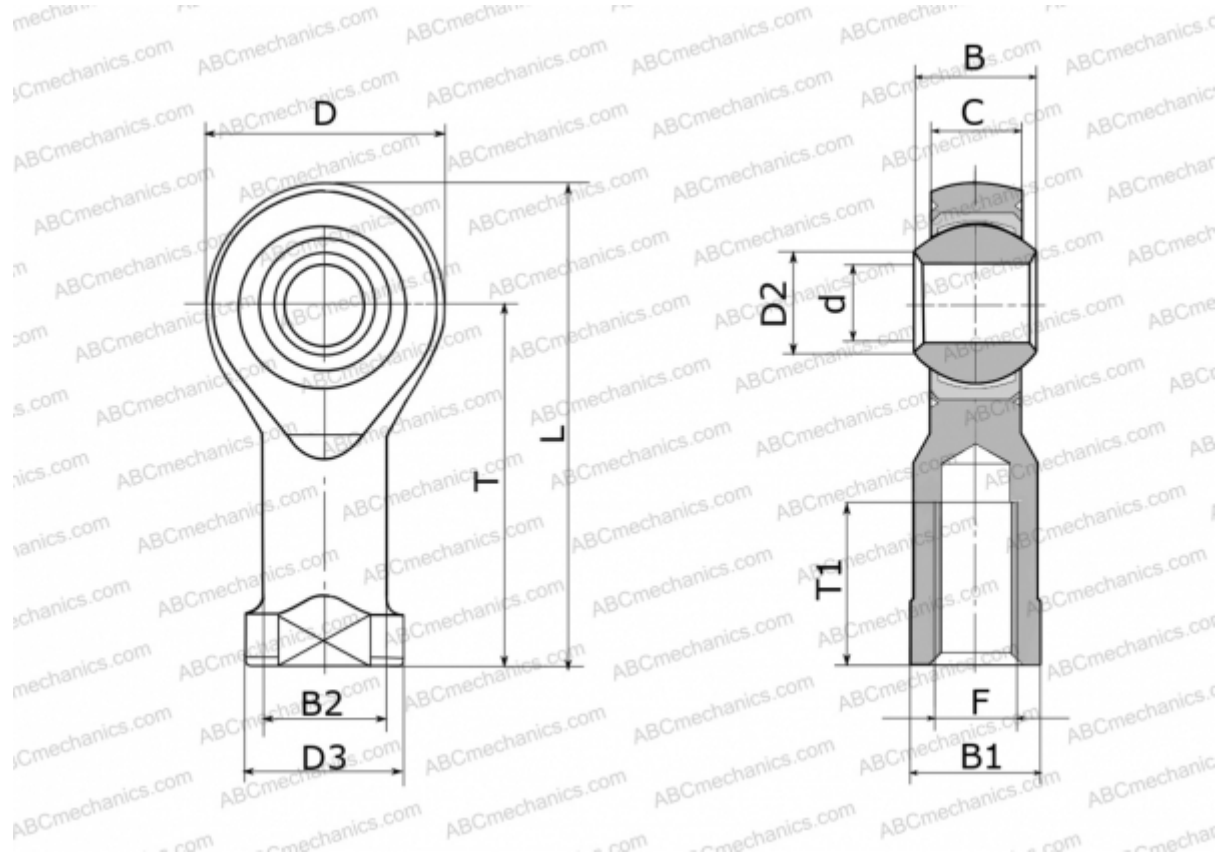

Technical specification

DIMENSIONS, MM

d	40,000
D	90,000
D2	44,200
D3	69,000
B	49,000
B1	60,000
B2	57,000
L	187,000
T	142,000
T1	60,000
C	35,000
F	M 42x2

MANUFACTURER

[FLURO](#)

WEIGHT, KG

2,770