

GALXSW 14 FLURO

TYPE: Plain bearings, Spherical plain bearings and rod ends, Rod ends, Maintenance free, With external thread, open design, left hand thread, series GALXSW (FLURO)

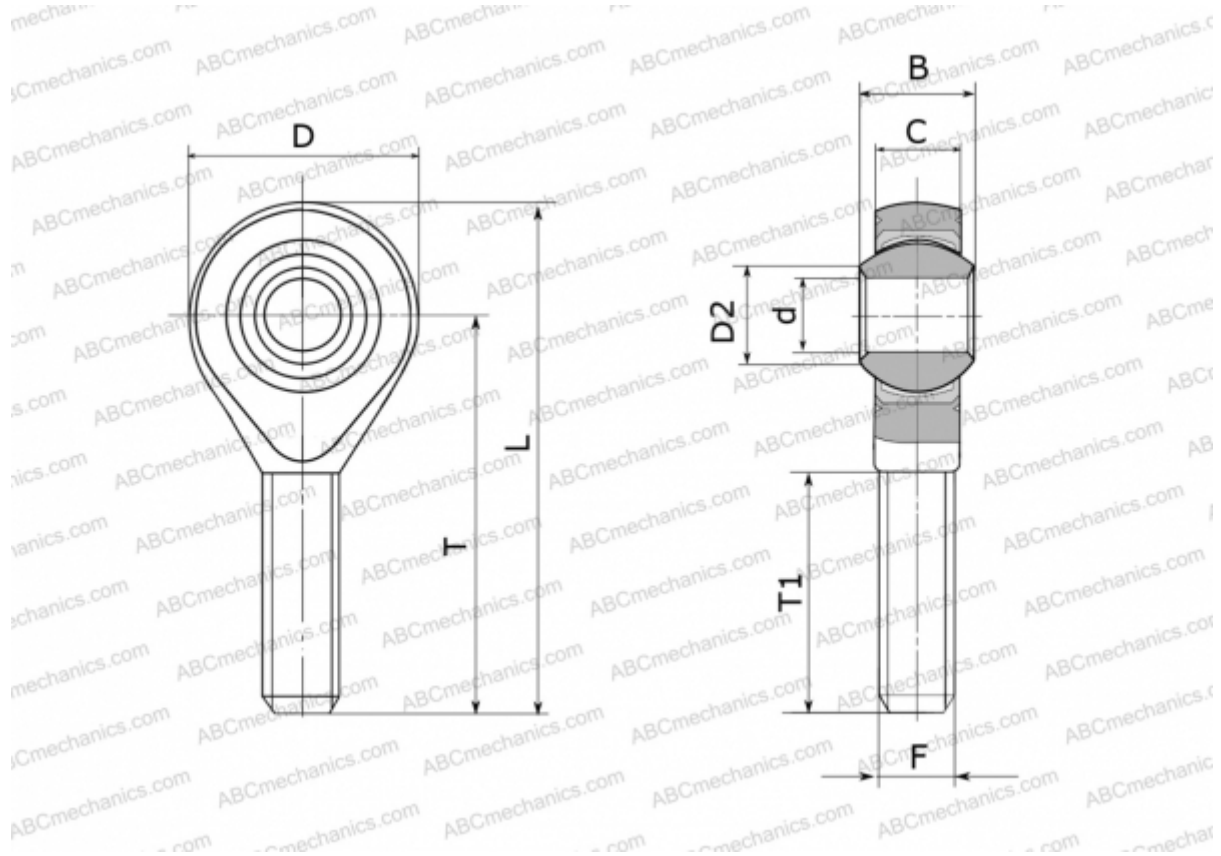

Technical specification

DIMENSIONS, MM

d	14,000
D	36,000
D2	16,800
B	19,000
L	78,000
T	60,000
T1	38,000
C	13,500
F	M 14

WEIGHT, KG 0,129

MANUFACTURER [FLURO](#)