

GIRSW 5 FLURO

TYPE: Plain bearings, Spherical plain bearings and rod ends, Rod ends, Maintenance free, With internal thread, open design, right hand thread, stainless steel, series GIRSW (FLURO)

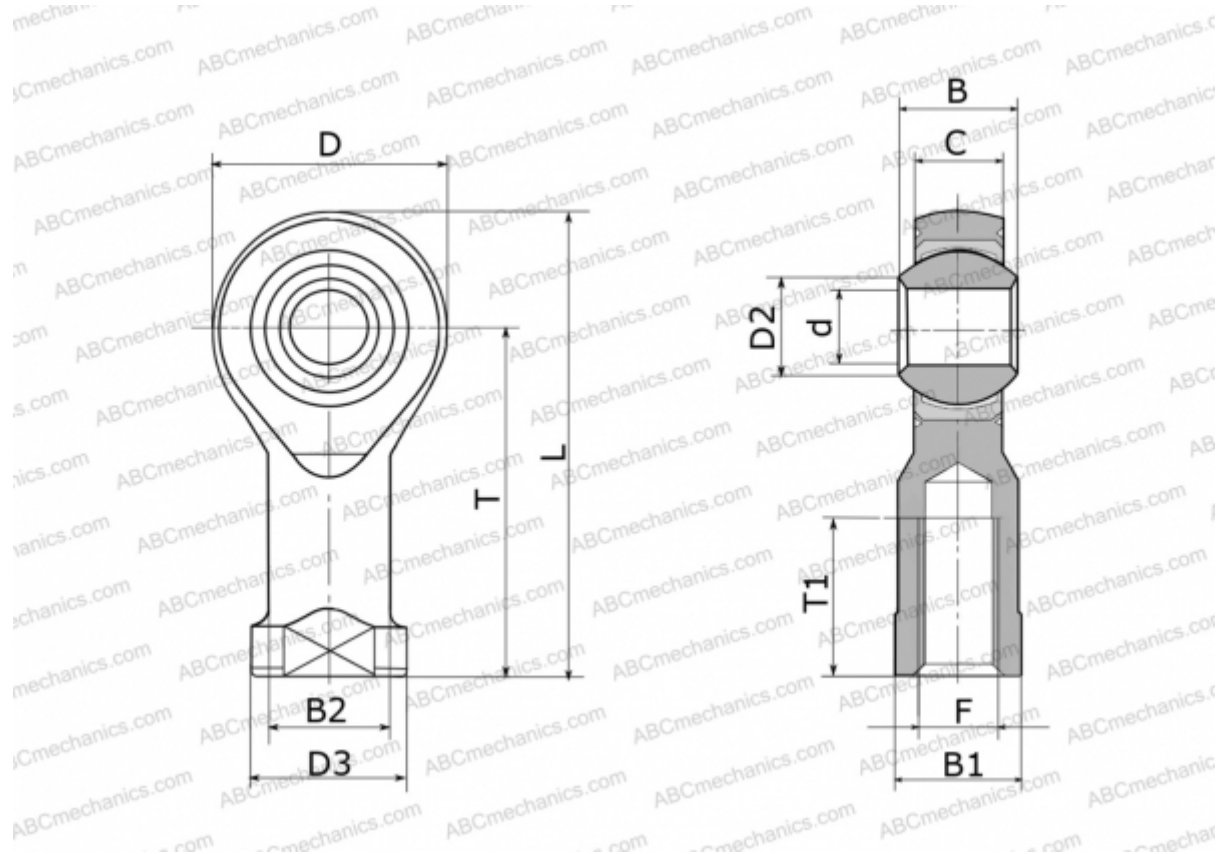

Technical specification

DIMENSIONS, MM

d	5,000
D	18,000
D2	7,700
D3	11,000
B	8,000
B1	9,000
B2	9,000
L	36,000
T	27,000
T1	10,000
C	6,000
F	M 5

MANUFACTURER

[FLURO](#)

WEIGHT, KG

0,018