

GIRSW 25 FLURO

TYPE: Plain bearings, Spherical plain bearings and rod ends, Rod ends, Maintenance free, With internal thread, open design, right hand thread, stainless steel, series GIRSW (FLURO)

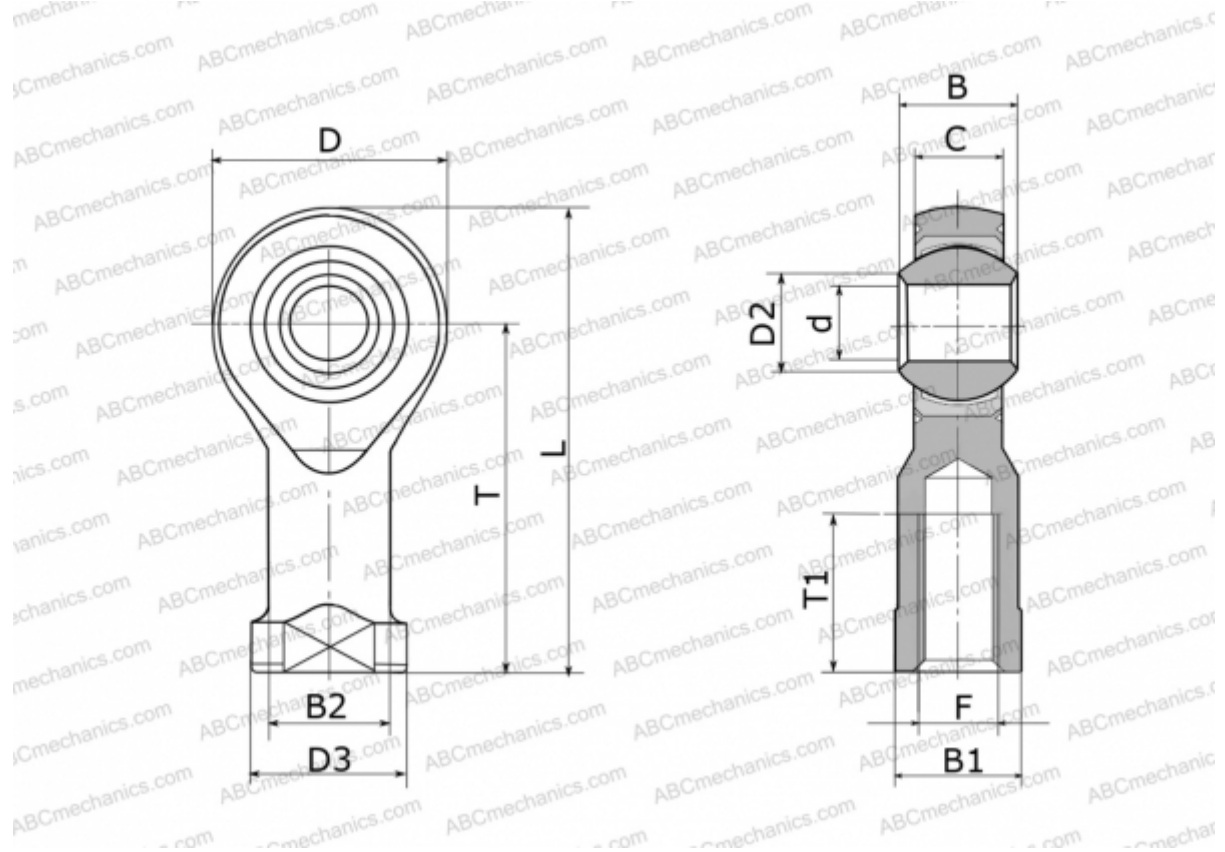

Technical specification

DIMENSIONS, MM

d	25,000
D	60,000
D2	29,600
D3	42,000
B	31,000
B1	36,000
B2	33,500
L	124,000
T	94,000
T1	42,000
C	22,000
F	M 24x2

MANUFACTURER

[FLURO](#)

WEIGHT, KG

0,750