

GILRSW 35 FLURO

TYPE: Plain bearings, Spherical plain bearings and rod ends, Rod ends, Maintenance free, With internal thread, open design, left hand thread, stainless steel, series GILRSW (FLURO)

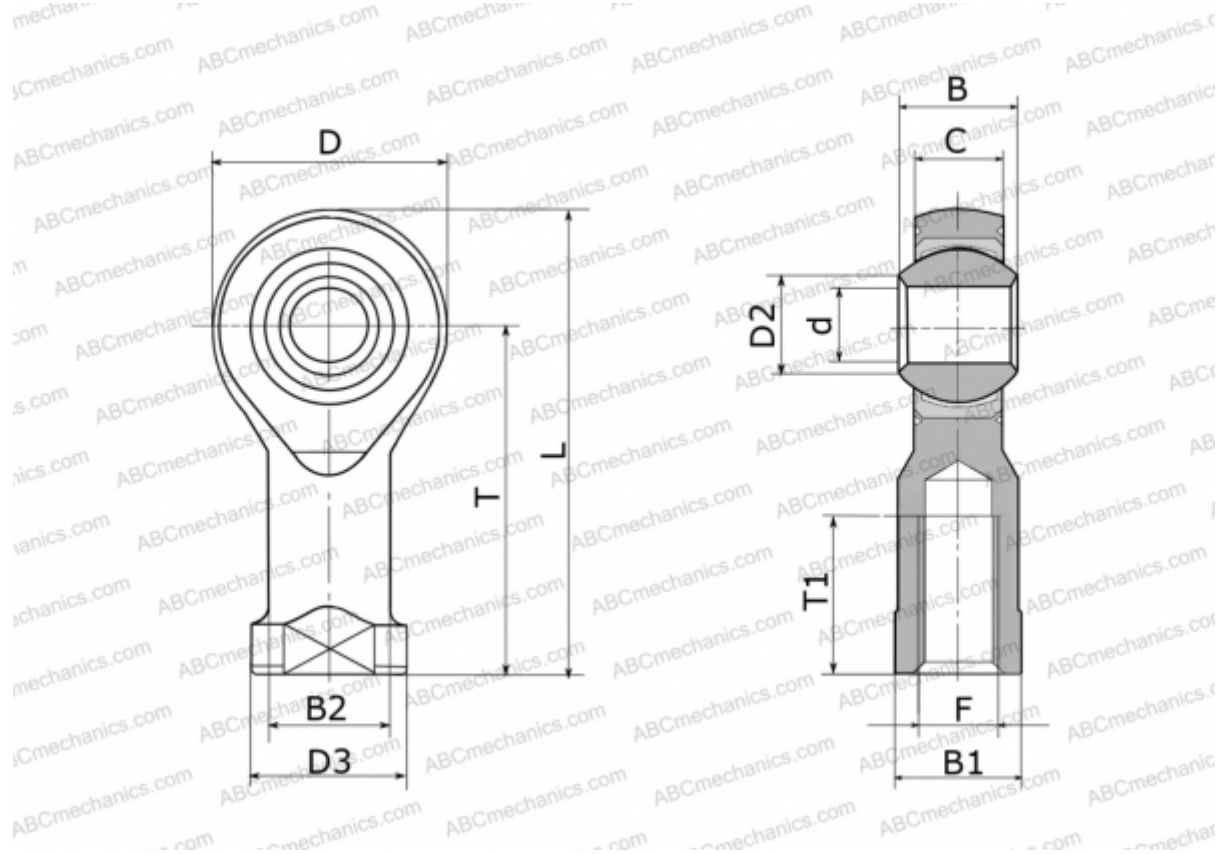

Technical specification

DIMENSIONS, MM

d	35,000
D	80,000
D2	37,700
D3	58,000
B	43,000
B1	50,000
B2	46,000
L	165,000
T	125,000
T1	56,000
C	28,000
F	M 36x2

MANUFACTURER

[FLURO](#)

WEIGHT, KG

1,600