

GARSW 35 FLURO

TYPE: Plain bearings, Spherical plain bearings and rod ends, Rod ends, Maintenance free, With external thread, open design, right hand thread, stainless steel, series GARSW (FLURO)

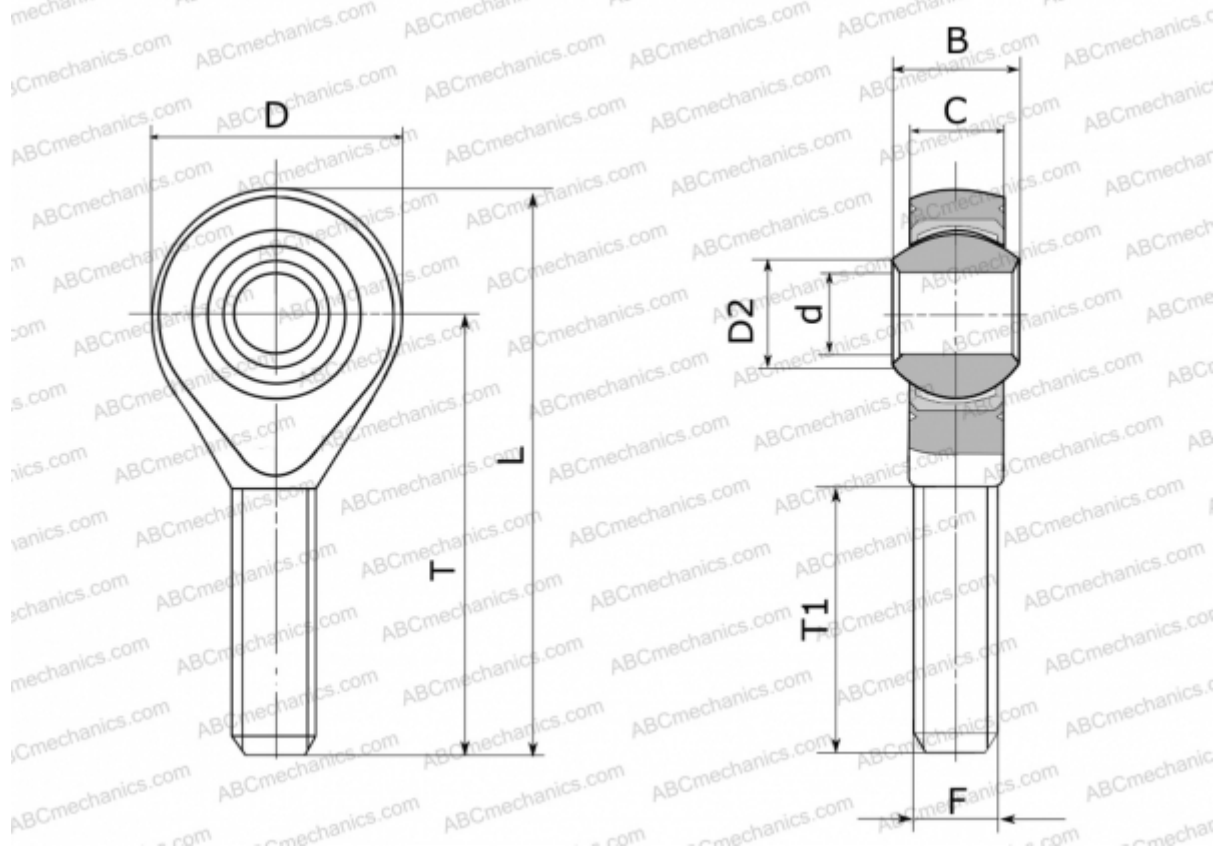

Technical specification

DIMENSIONS, MM

d	35,000
D	80,000
D2	37,700
B	43,000
L	165,000
T	125,000
T1	73,000
C	28,000
F	M 36x2

WEIGHT, KG 1,600

MANUFACTURER [FLURO](#)