

GALRSW 4 FLURO

TYPE: Plain bearings, Spherical plain bearings and rod ends, Rod ends, Maintenance free, With external thread, open design, left hand thread, stainless steel, series GALRSW (FLURO)

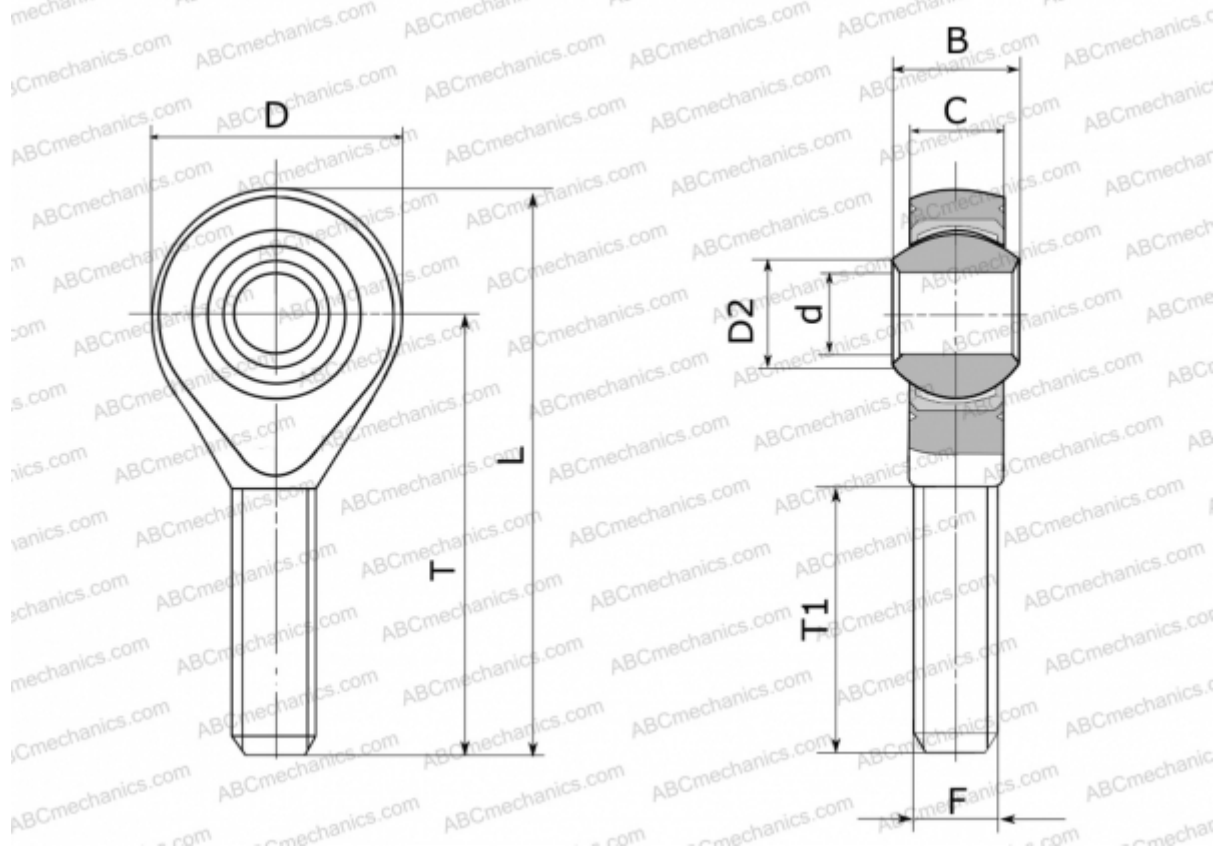

Technical specification

DIMENSIONS, MM

d	4,000
D	14,000
D2	6,500
B	7,000
L	37,000
T	30,000
T1	19,000
C	5,250
F	M 4

WEIGHT, KG 0,009

MANUFACTURER [FLURO](#)