

GALRSW 5 FLURO

TYPE: Plain bearings, Spherical plain bearings and rod ends, Rod ends, Maintenance free, With external thread, open design, left hand thread, stainless steel, series GALRSW (FLURO)

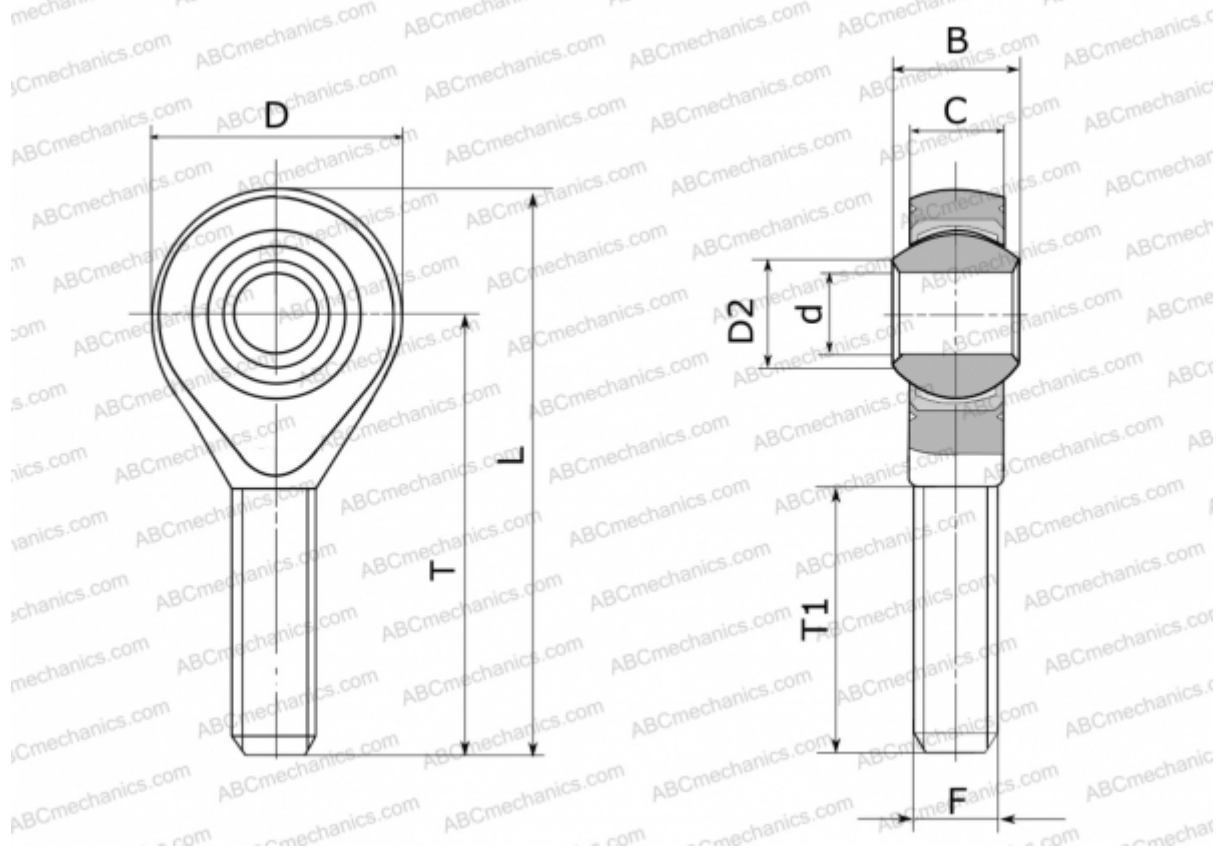

Technical specification

DIMENSIONS, MM

d	5,000
D	18,000
D2	7,700
B	8,000
L	42,000
T	33,000
T1	19,000
C	6,000
F	M 5

WEIGHT, KG 0,013

MANUFACTURER [FLURO](#)