

GALRSW 12 FLURO

TYPE: Plain bearings, Spherical plain bearings and rod ends, Rod ends, Maintenance free, With external thread, open design, left hand thread, stainless steel, series GALRSW (FLURO)

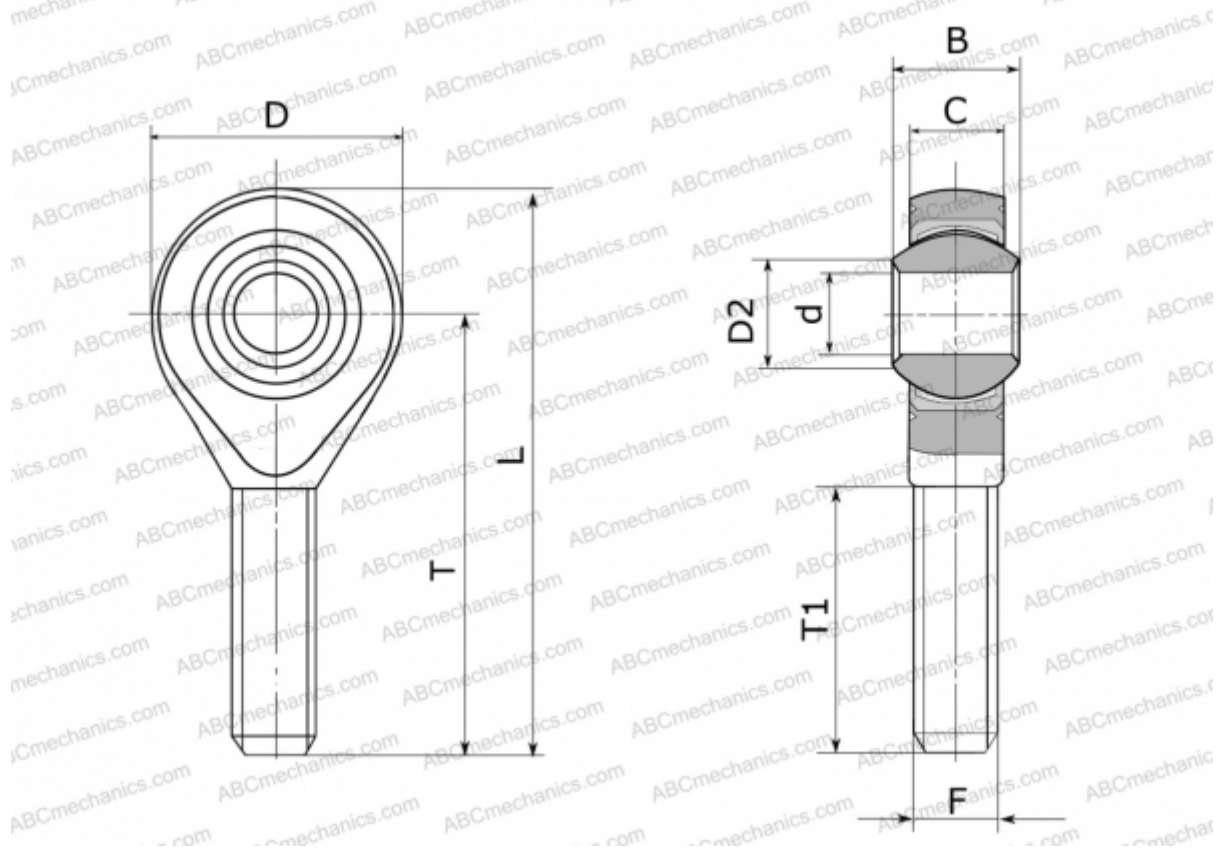

Technical specification

DIMENSIONS, MM

d	12,000
D	32,000
D2	15,400
B	16,000
L	70,000
T	54,000
T1	32,000
C	12,000
F	M 12

WEIGHT, KG 0,087

MANUFACTURER [FLURO](#)