

## GALRSW 18 FLURO

TYPE: Plain bearings, Spherical plain bearings and rod ends, Rod ends, Maintenance free, With external thread, open design, left hand thread, stainless steel, series GALRSW (FLURO)

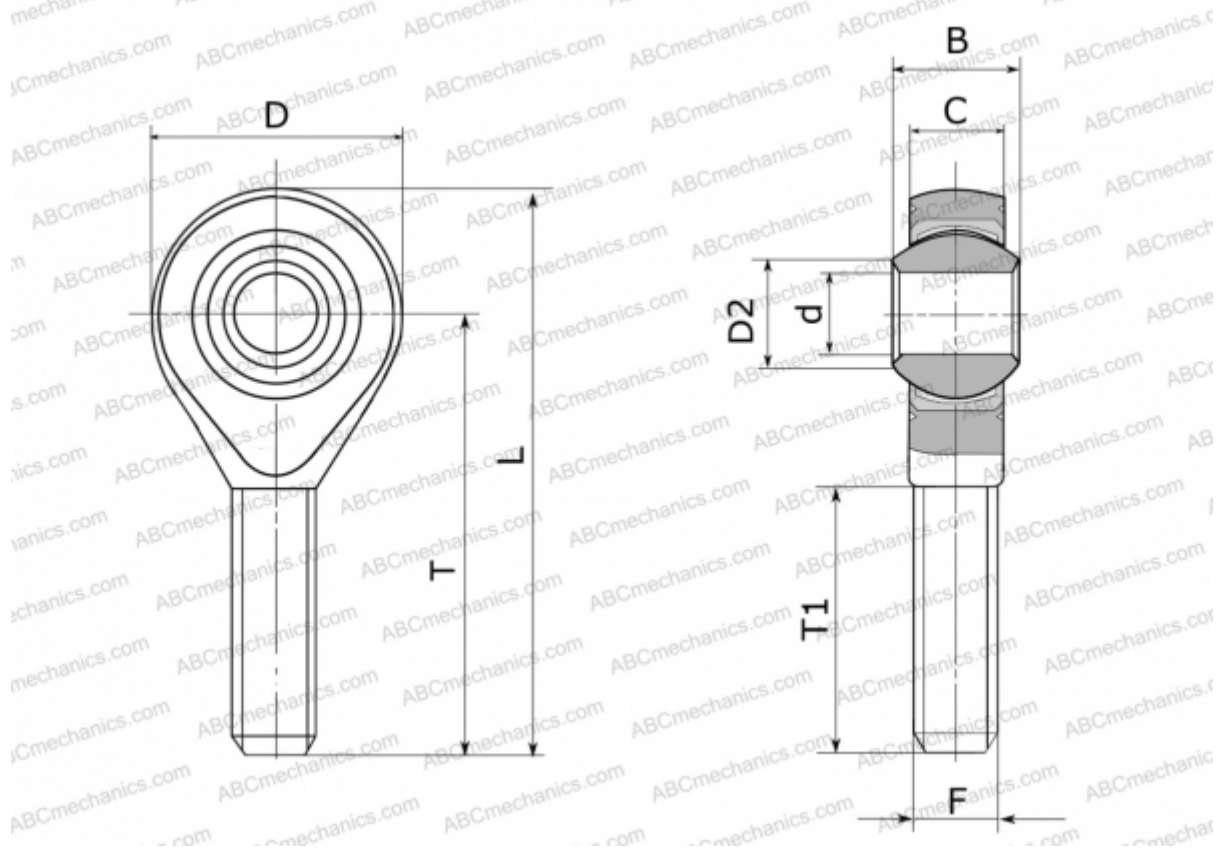

### Technical specification

#### DIMENSIONS, MM

d	18,000
D	46,000
D2	21,800
B	23,000
L	95,000
T	72,000
T1	44,000
C	16,500
F	M 18x1.5

**WEIGHT, KG** 0,267

**MANUFACTURER** [FLURO](#)