

GIO 14 FLURO

TYPE: Plain bearings, Spherical plain bearings and rod ends, Rod ends, Maintenance free, With internal thread, open design, right hand thread, series GIO (FLURO)

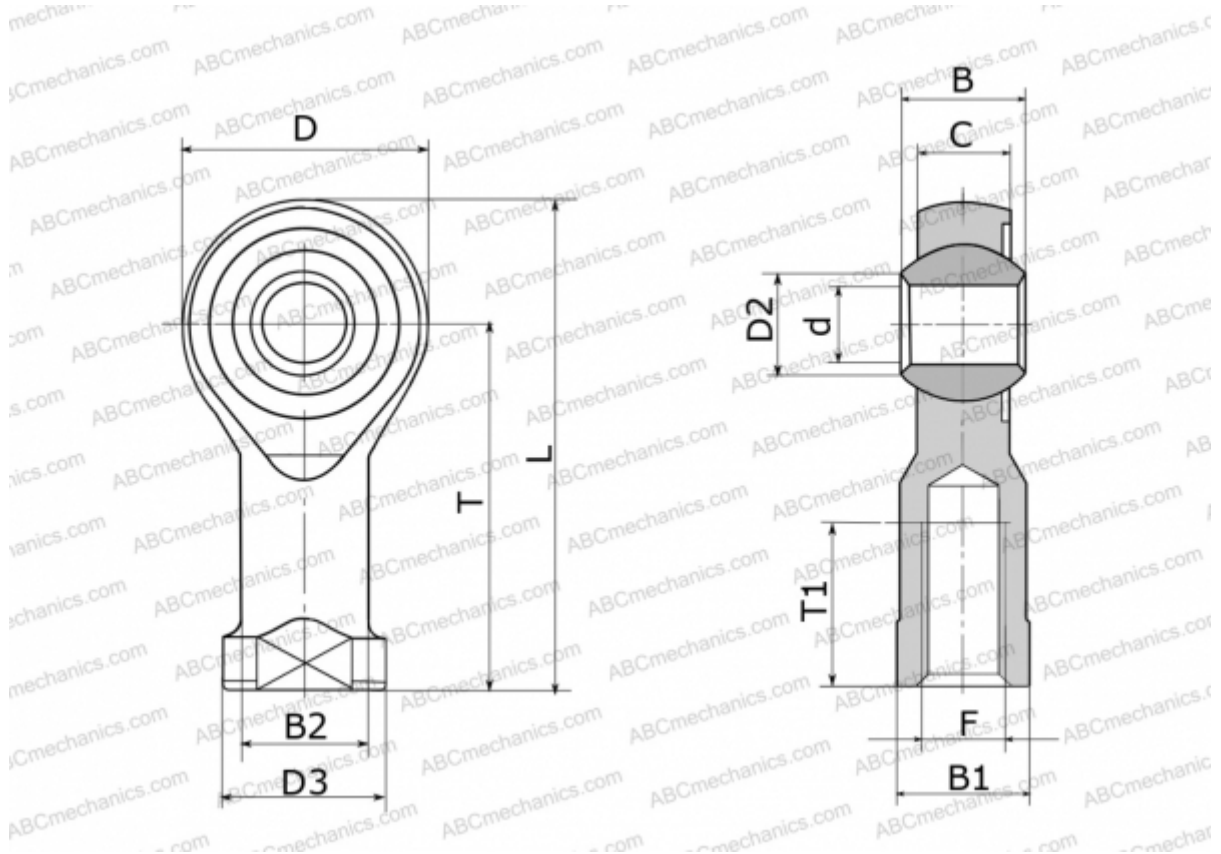

Technical specification

DIMENSIONS, MM

d	14,000
D	36,000
D2	16,800
D3	25,000
B	19,000
B1	22,000
B2	20,000
L	75,000
T	57,000
T1	25,000
C	13,500
F	M 14

MANUFACTURER

[FLURO](#)

WEIGHT, KG

0,170