

GAO 10 FLURO

TYPE: Plain bearings, Spherical plain bearings and rod ends, Rod ends, Maintenance free, With external thread, open design, right hand thread, series GAO (FLURO)

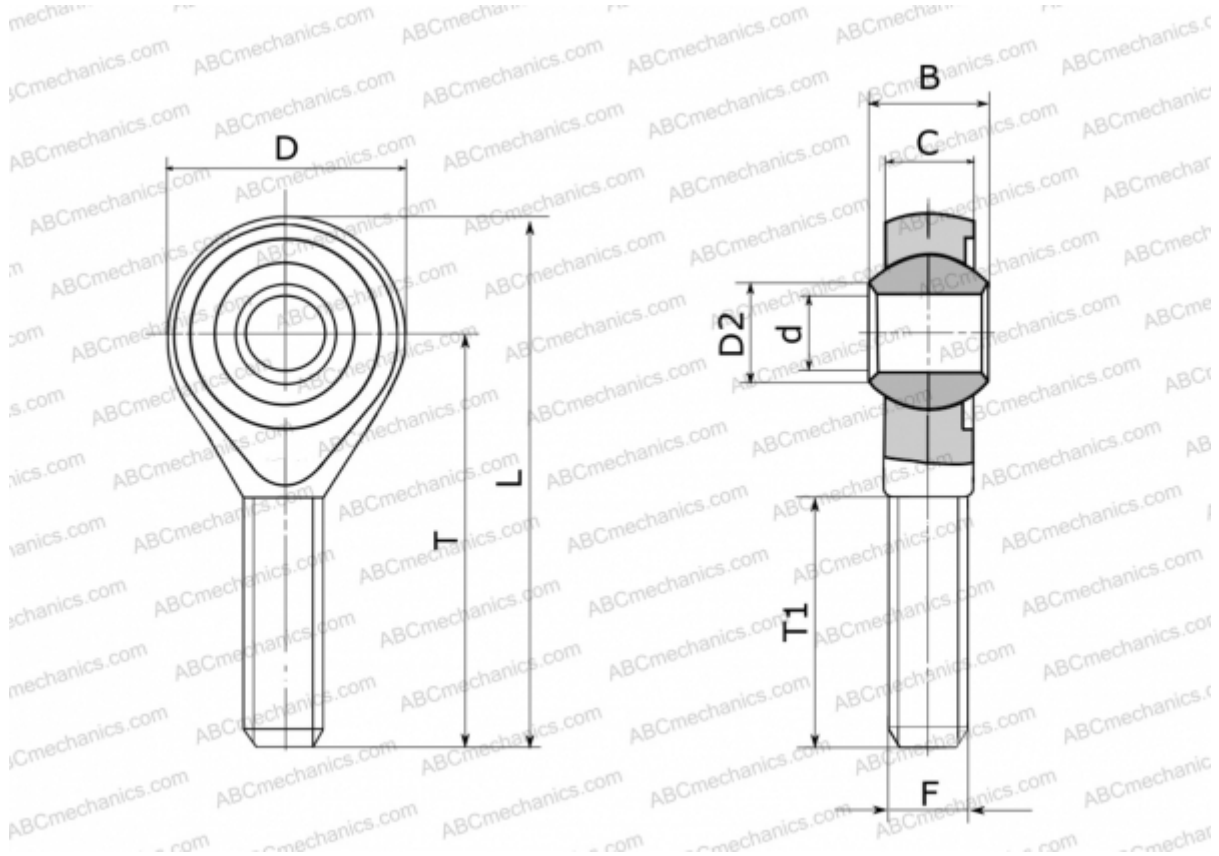

Technical specification

DIMENSIONS, MM

d	10,000
D	28,000
D2	12,900
B	14,000
L	62,000
T	48,000
T1	28,000
C	10,500
F	M 10

WEIGHT, KG 0,056

MANUFACTURER [FLURO](#)