

GILOW 4 FLURO

TYPE: Plain bearings, Spherical plain bearings and rod ends, Rod ends, Maintenance free, With internal thread, open design, left hand thread, series GILOW (FLURO)

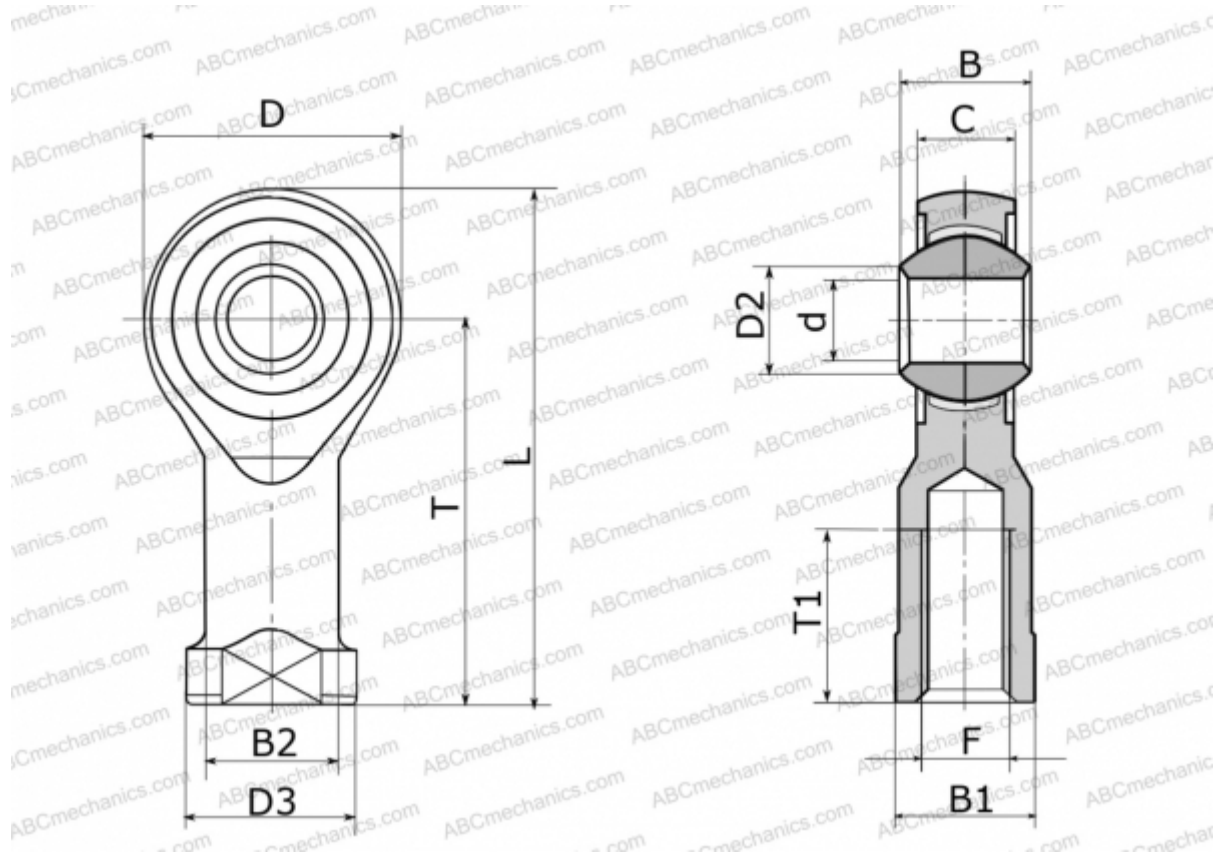

Technical specification

DIMENSIONS, MM

d	4,000
D	14,000
D2	6,500
D3	9,500
B	7,000
B1	8,000
B2	7,800
L	31,000
T	24,000
T1	12,000
C	5,250
F	M 4

MANUFACTURER

[FLURO](#)

WEIGHT, KG

0,011