

G...8-2RS FLURO

TYPE: Plain bearings, Spherical plain bearings and rod ends, Rod ends, Maintenance free, Contact seals on both side, series G...-2RS (FLURO)

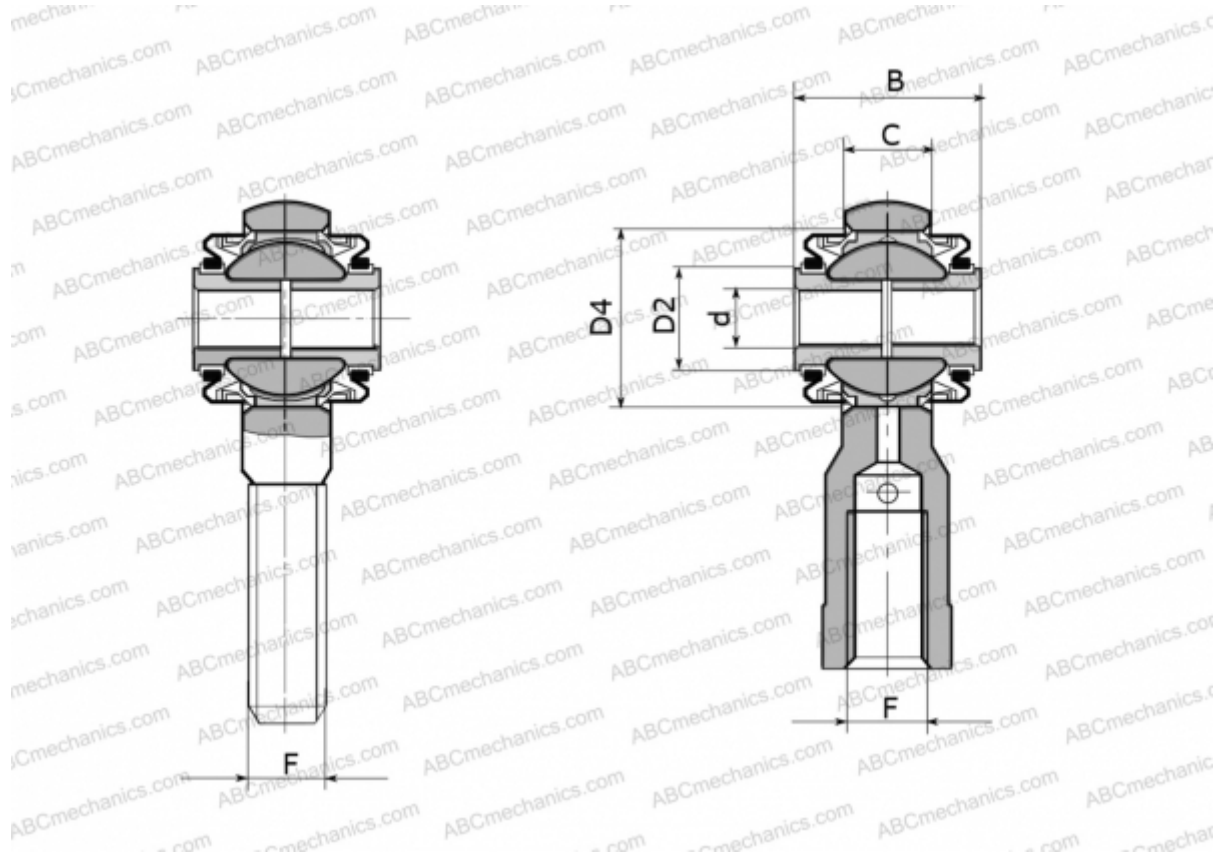

Technical specification

DIMENSIONS, MM

d	6,000
D2	10,500
D4	18,000
B	19,000
C	9,000
F	M 8

MANUFACTURER

[FLURO](#)