

G...16-2RS FLURO

TYPE: Plain bearings, Spherical plain bearings and rod ends, Rod ends, Maintenance free, Contact seals on both side, series G...-2RS (FLURO)

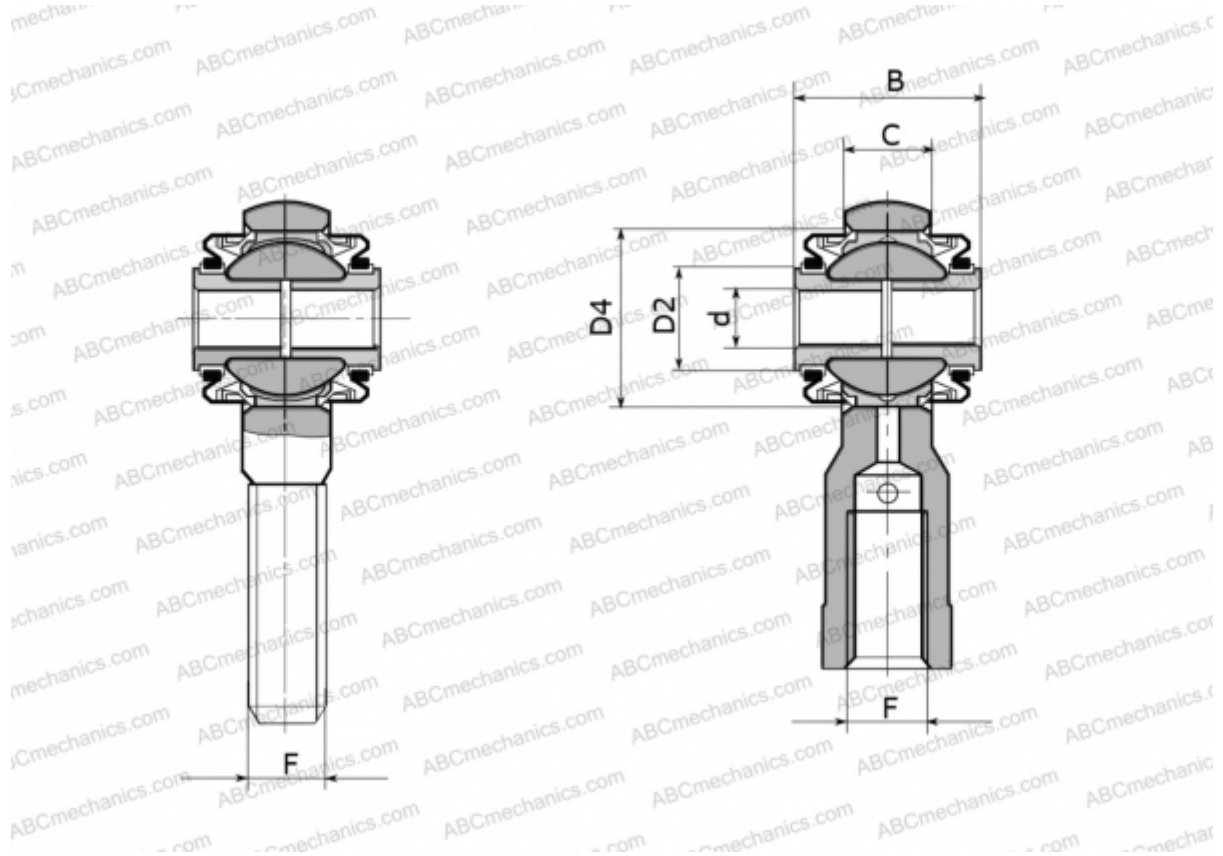

Technical specification

DIMENSIONS, MM

d	14,000
D2	18,500
D4	32,000
B	28,000
C	15,000
F	M 16

MANUFACTURER

[FLURO](#)