

GIR17-DO ELGES

TYPE: Plain bearings, Spherical plain bearings and rod ends, Rod ends, Requiring maintenance, With internal thread, open design, right hand thread, series GIR.-DO (INA)

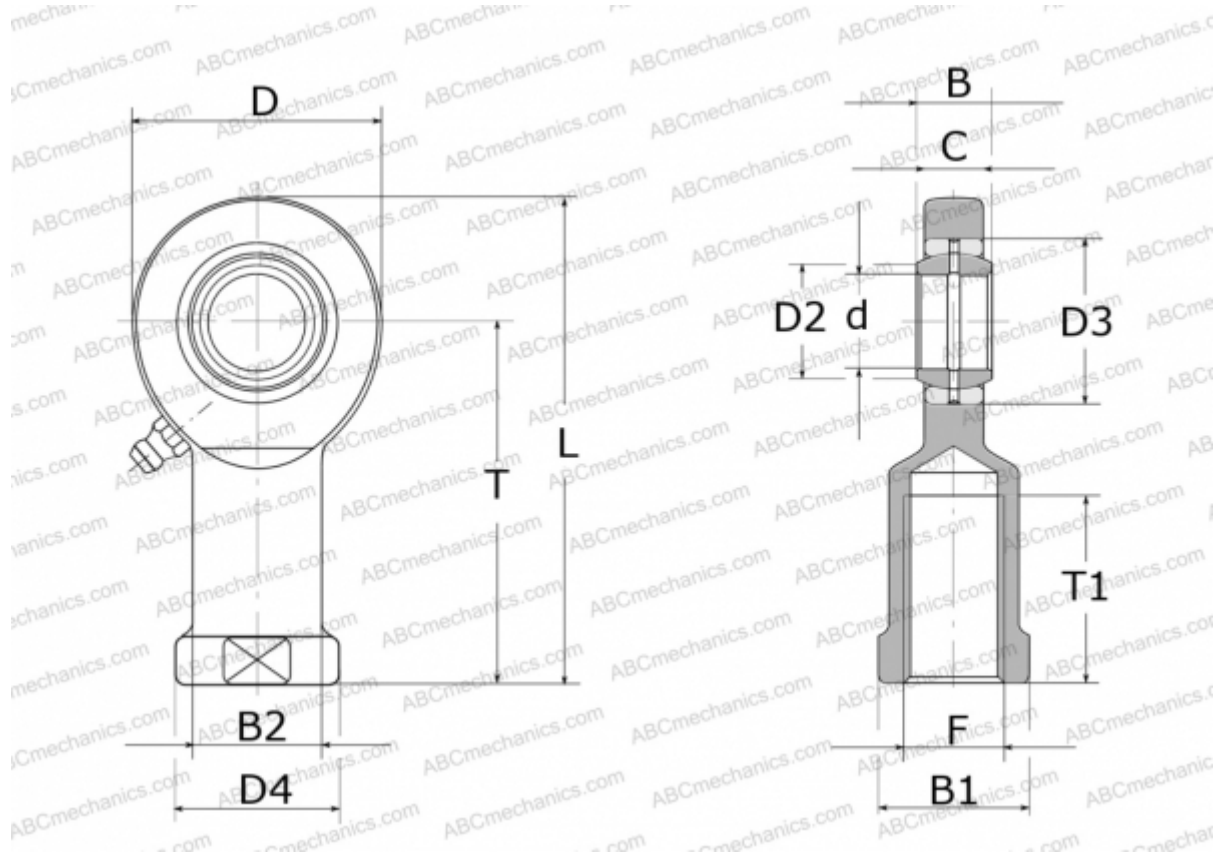

Technical specification

DIMENSIONS, MM

d	17,000
D	46,000
D2	20,700
D3	30,000
D4	30,000
B	14,000
B1	27,000
B2	24,000
L	90,000
T	67,000
T1	34,000
C	11,000
F	M16

MANUFACTURER

[ELGES](#)

WEIGHT, KG

0,250