

GIL6-DO ELGES

TYPE: Plain bearings, Spherical plain bearings and rod ends, Rod ends, Requiring maintenance, With internal thread, open design, left hand thread, series GIL..-DO (INA)

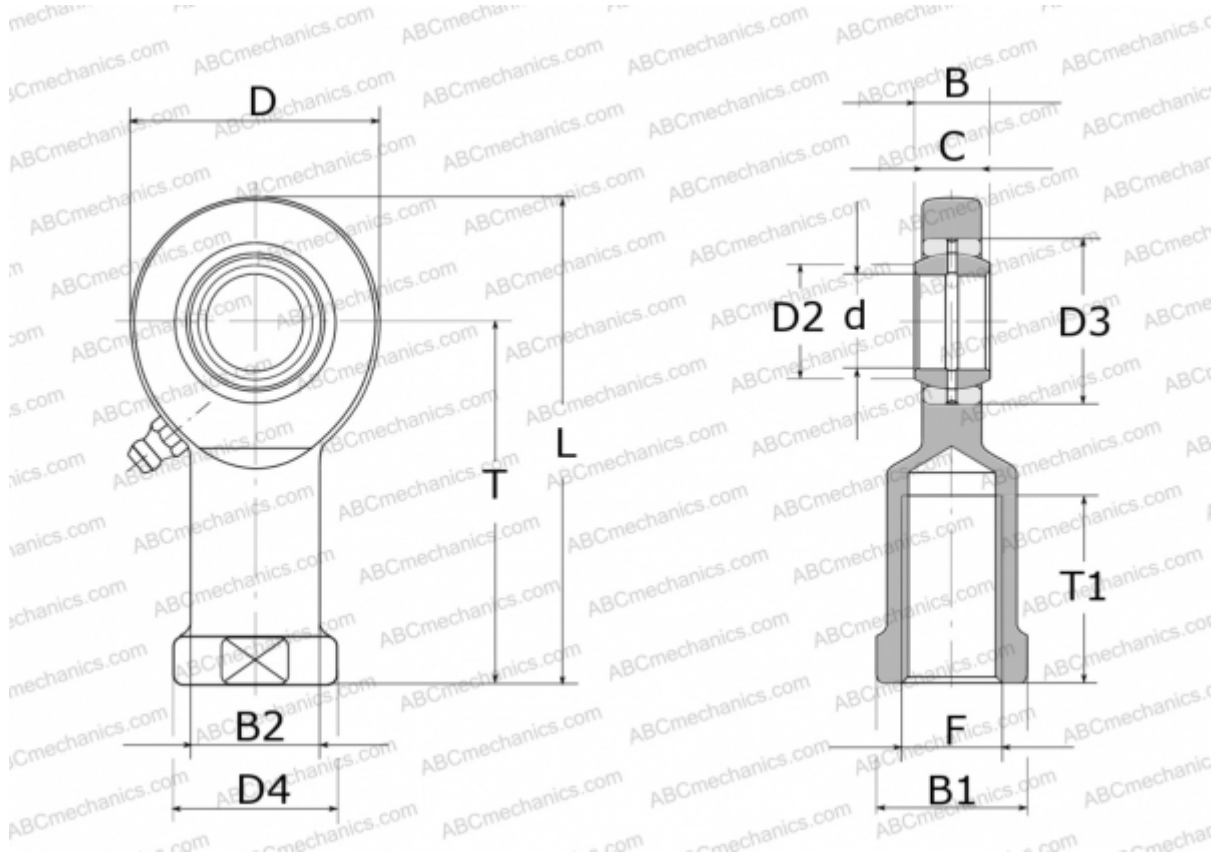

Technical specification

DIMENSIONS, MM

d	6,000
D	21,000
D2	8,000
D3	14,000
D4	13,000
B	6,000
B1	11,000
B2	10,000
L	40,500
T	30,000
T1	11,000
C	4,400
F	M6

MANUFACTURER

[ELGES](#)

WEIGHT, KG

0,023