

GIL70-DO-2RS ELGES

TYPE: Plain bearings, Spherical plain bearings and rod ends, Rod ends, Requiring maintenance, With internal thread, with lip seals or high performance seals, left hand thread, series GIL.-DO-2RS (INA)

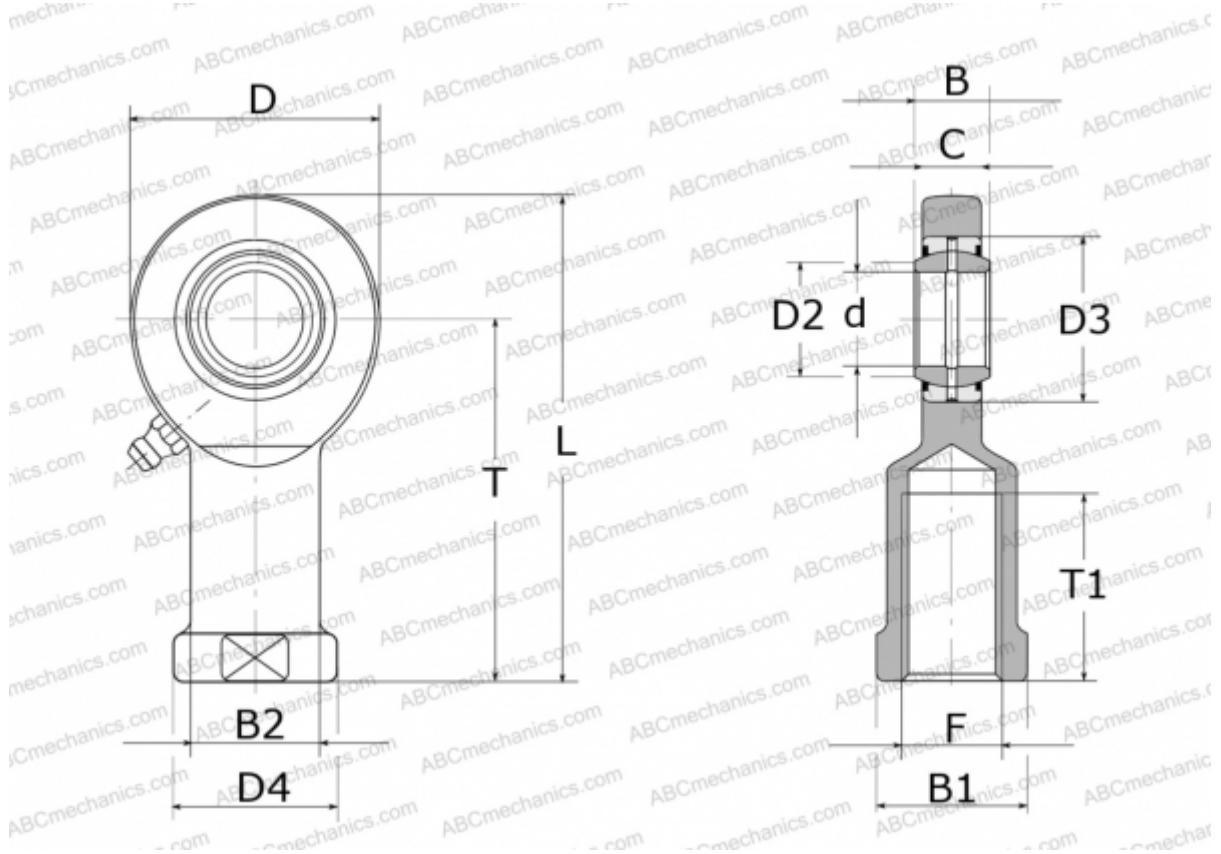

Technical specification

DIMENSIONS, MM

d	70,000
D	160,000
D2	77,900
D3	105,000
D4	98,000
B	49,000
B1	85,000
B2	80,000
L	280,000
T	200,000
T1	80,000
C	42,000
F	M56X4

MANUFACTURER

[ELGES](#)

WEIGHT, KG

8,620