

GAL6-DO ELGES

TYPE: Plain bearings, Spherical plain bearings and rod ends, Rod ends, Requiring maintenance, With external thread, open design, left hand thread, series GAL.-DO (INA)

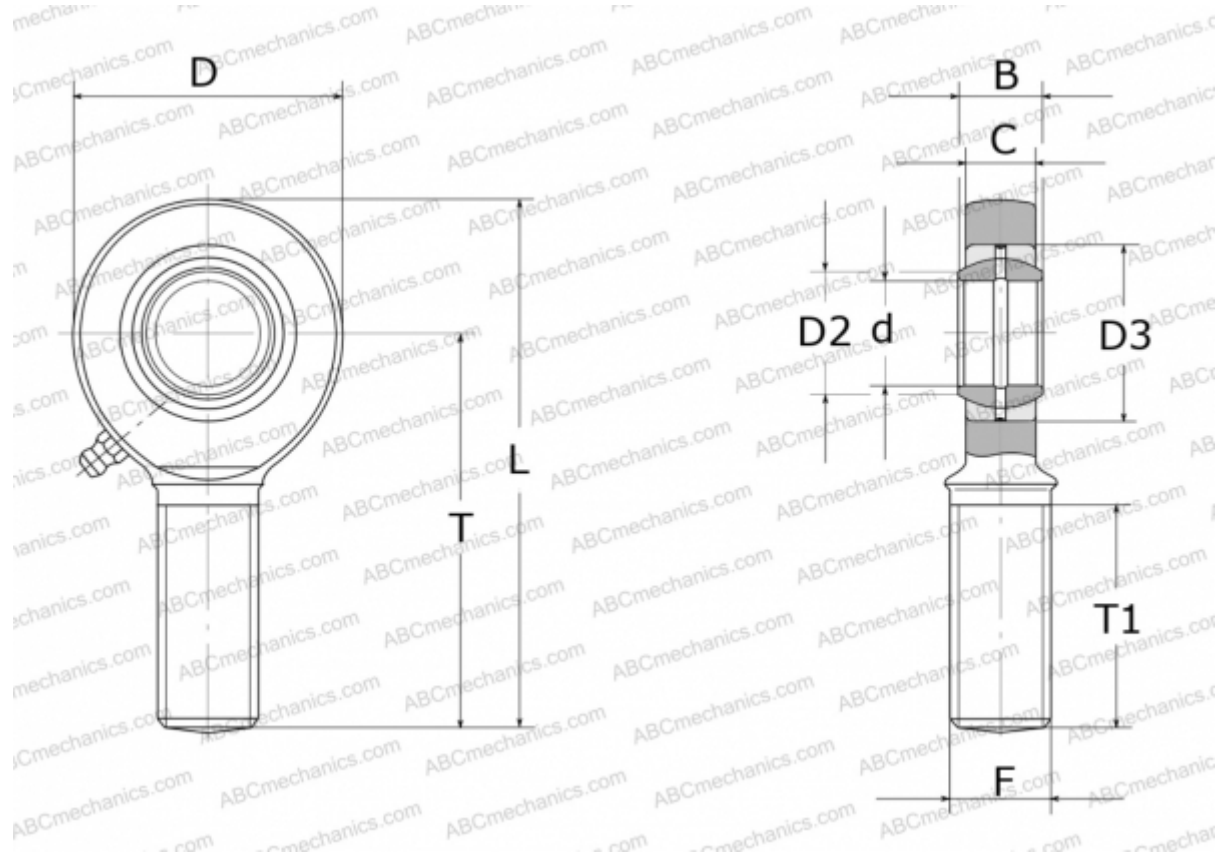

Technical specification

DIMENSIONS, MM

d	6,000
D	21,000
D2	8,000
D3	14,000
B	6,000
L	46,500
T	36,000
T1	18,000
C	4,400
F	M6

WEIGHT, KG 0,018

MANUFACTURER [ELGES](#)