

GAL8-DO ELGES

TYPE: Plain bearings, Spherical plain bearings and rod ends, Rod ends, Requiring maintenance, With external thread, open design, left hand thread, series GAL.-DO (INA)

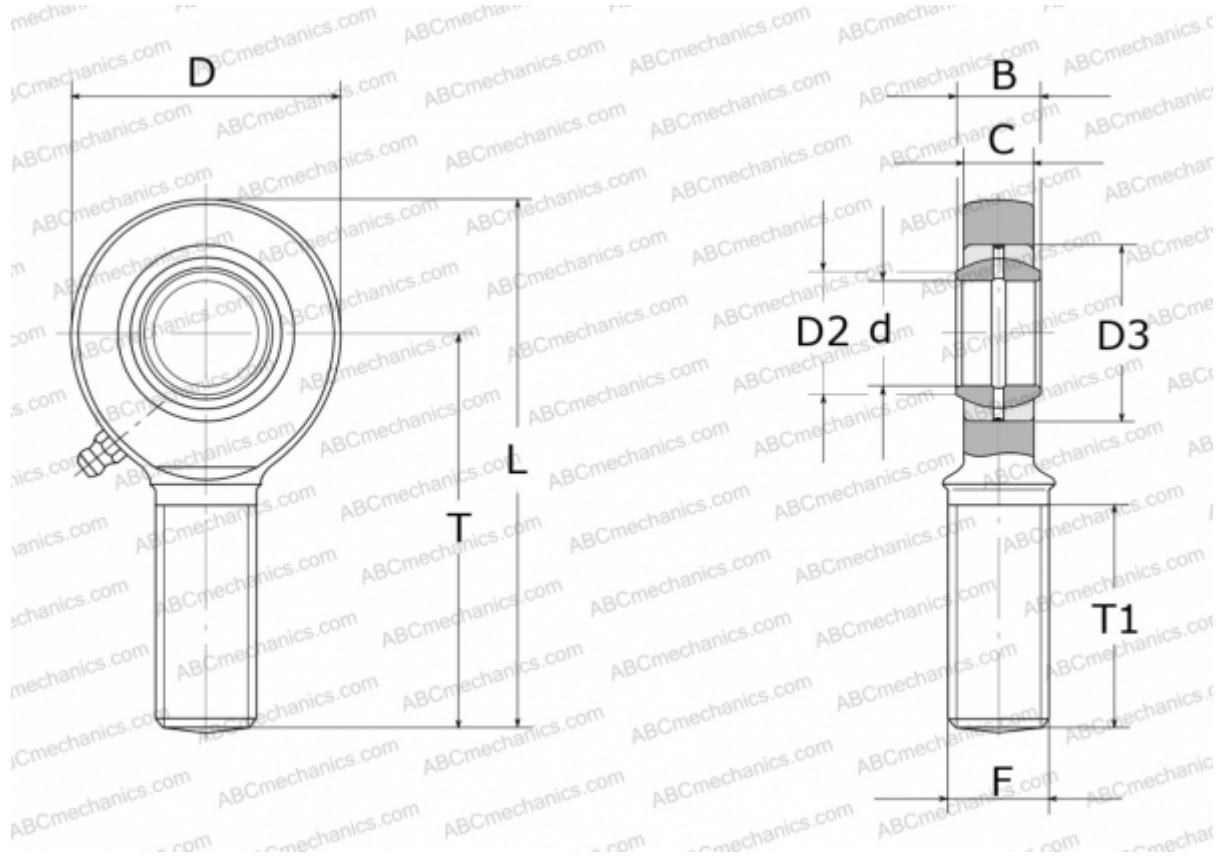

Technical specification

DIMENSIONS, MM

d	8,000
D	24,000
D2	10,200
D3	16,000
B	8,000
L	54,000
T	42,000
T1	22,000
C	6,000
F	M8

WEIGHT, KG 0,033

MANUFACTURER [ELGES](#)