

GAL10-DO ELGES

TYPE: Plain bearings, Spherical plain bearings and rod ends, Rod ends, Requiring maintenance, With external thread, open design, left hand thread, series GAL.-DO (INA)

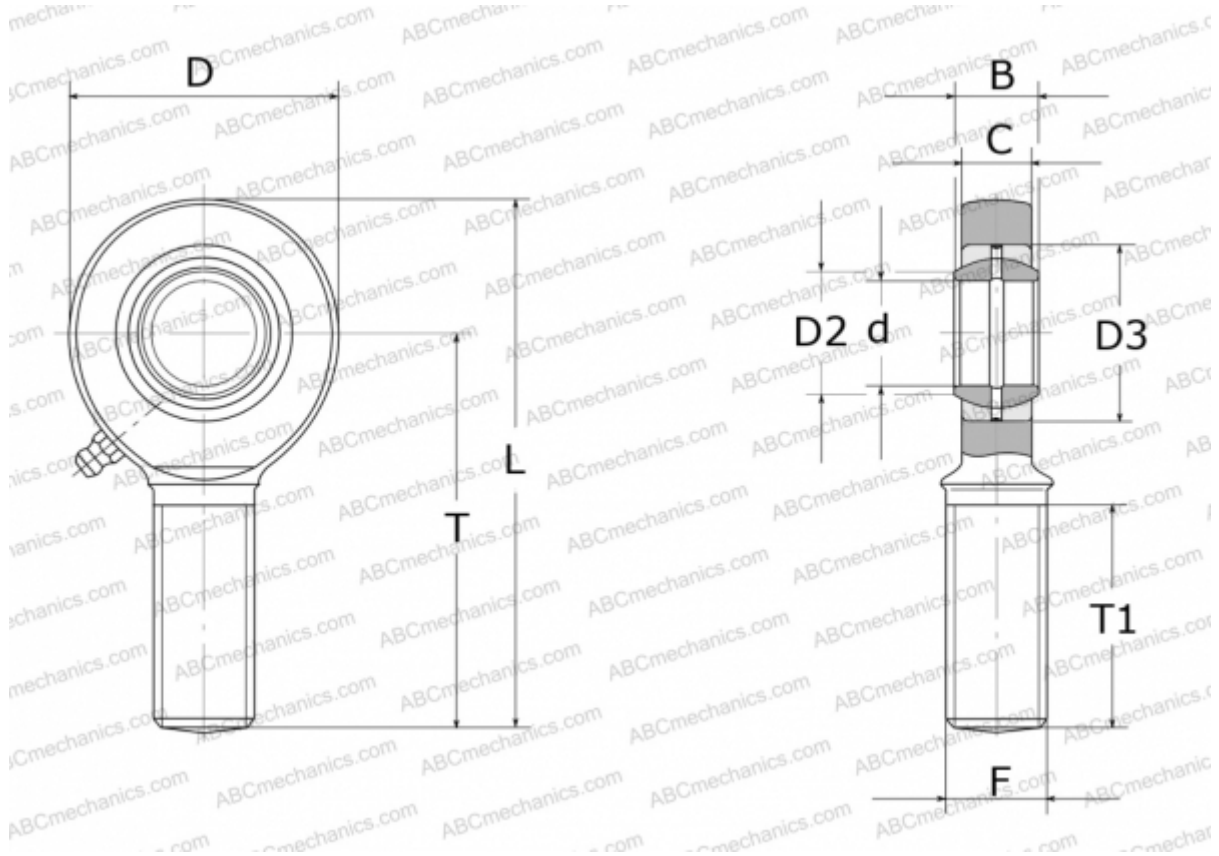

Technical specification

DIMENSIONS, MM

d	10,000
D	29,000
D2	13,200
D3	19,000
B	9,000
L	62,500
T	48,000
T1	26,000
C	7,000
F	M10

WEIGHT, KG 0,056

MANUFACTURER [ELGES](#)