

GAL25-DO-2RS ELGES

TYPE: Plain bearings, Spherical plain bearings and rod ends, Rod ends, Requiring maintenance, With external thread, with lip seals or high performance seals, left hand thread, series GAL..-DO-2RS (INA)

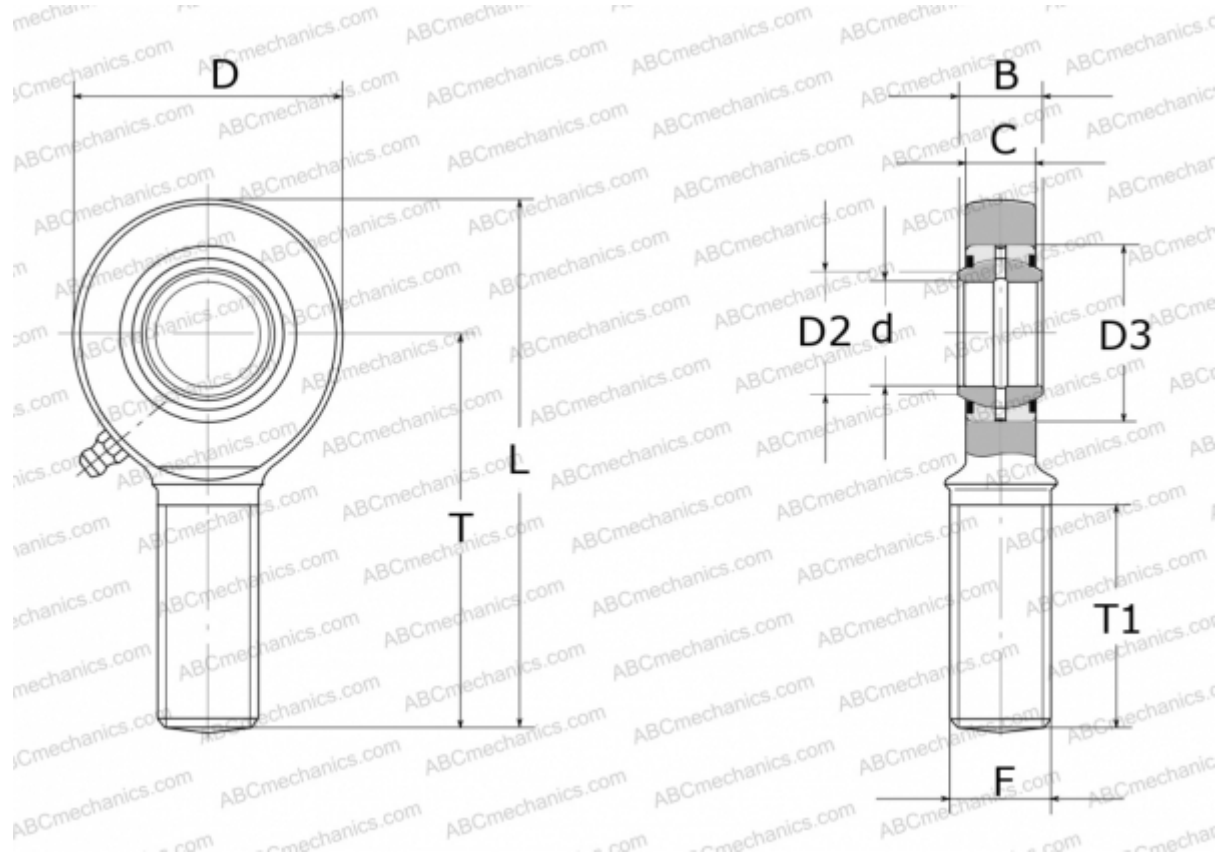

Technical specification

DIMENSIONS, MM

d	25,000
D	64,000
D2	29,300
D3	42,000
B	20,000
L	126,000
T	94,000
T1	53,000
C	17,000
F	M24X2

WEIGHT, KG 0,600

MANUFACTURER [ELGES](#)