

GAL30-DO-2RS ELGES

TYPE: Plain bearings, Spherical plain bearings and rod ends, Rod ends, Requiring maintenance, With external thread, with lip seals or high performance seals, left hand thread, series GAL..-DO-2RS (INA)

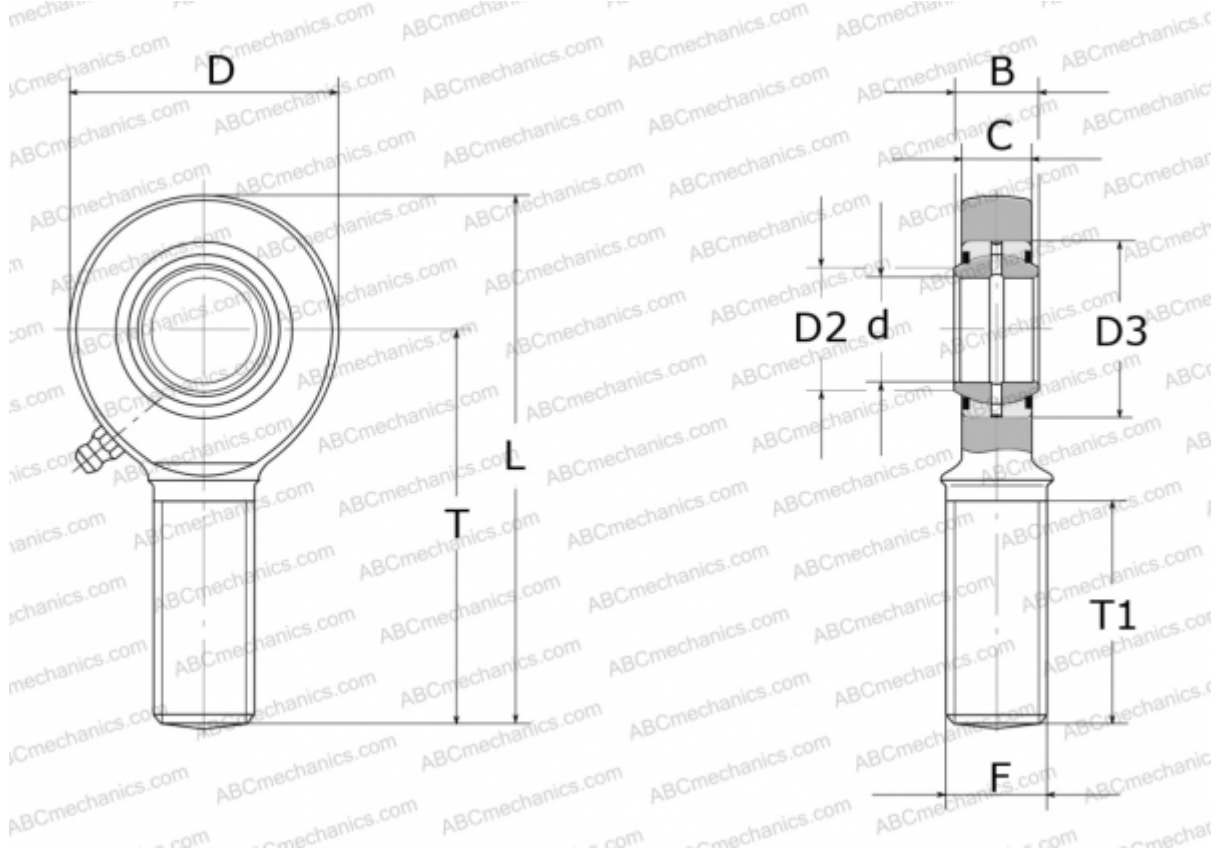

Technical specification

DIMENSIONS, MM

d	30,000
D	73,000
D2	34,200
D3	47,000
B	22,000
L	146,500
T	110,000
T1	65,000
C	19,000
F	M30X2

WEIGHT, KG 0,950

MANUFACTURER [ELGES](#)