

## GAL50-DO-2RS ELGES

TYPE: Plain bearings, Spherical plain bearings and rod ends, Rod ends, Requiring maintenance, With external thread, with lip seals or high performance seals, left hand thread, series GAL..-DO-2RS (INA)

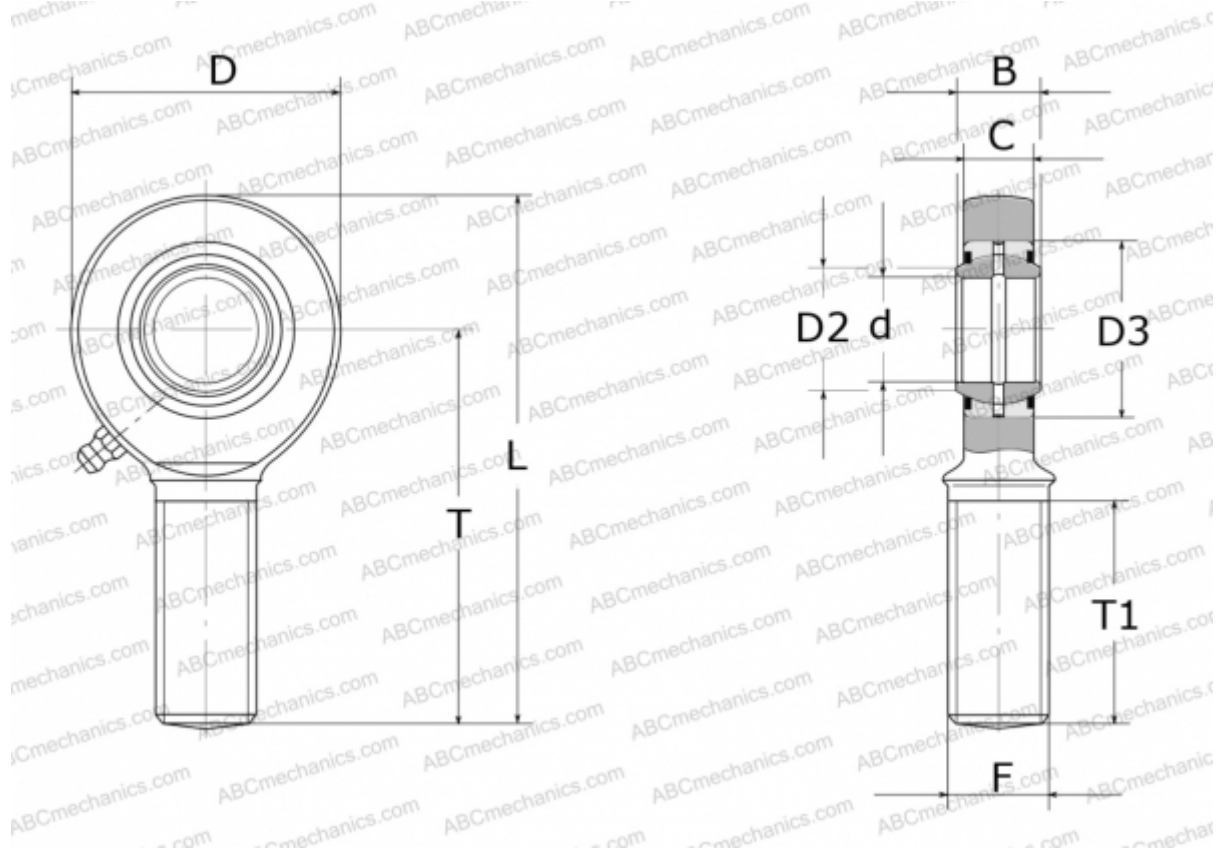

### Technical specification

#### DIMENSIONS, MM

d	50,000
D	112,000
D2	56,000
D3	75,000
B	35,000
L	241,000
T	185,000
T1	107,000
C	30,000
F	M45X3

**WEIGHT, KG** 3,530

**MANUFACTURER** [ELGES](#)