

GI 22 FLURO

TYPE: Plain bearings, Spherical plain bearings and rod ends, Rod ends, Requiring maintenance, With internal thread, open design, right hand thread, series GI (FLURO)

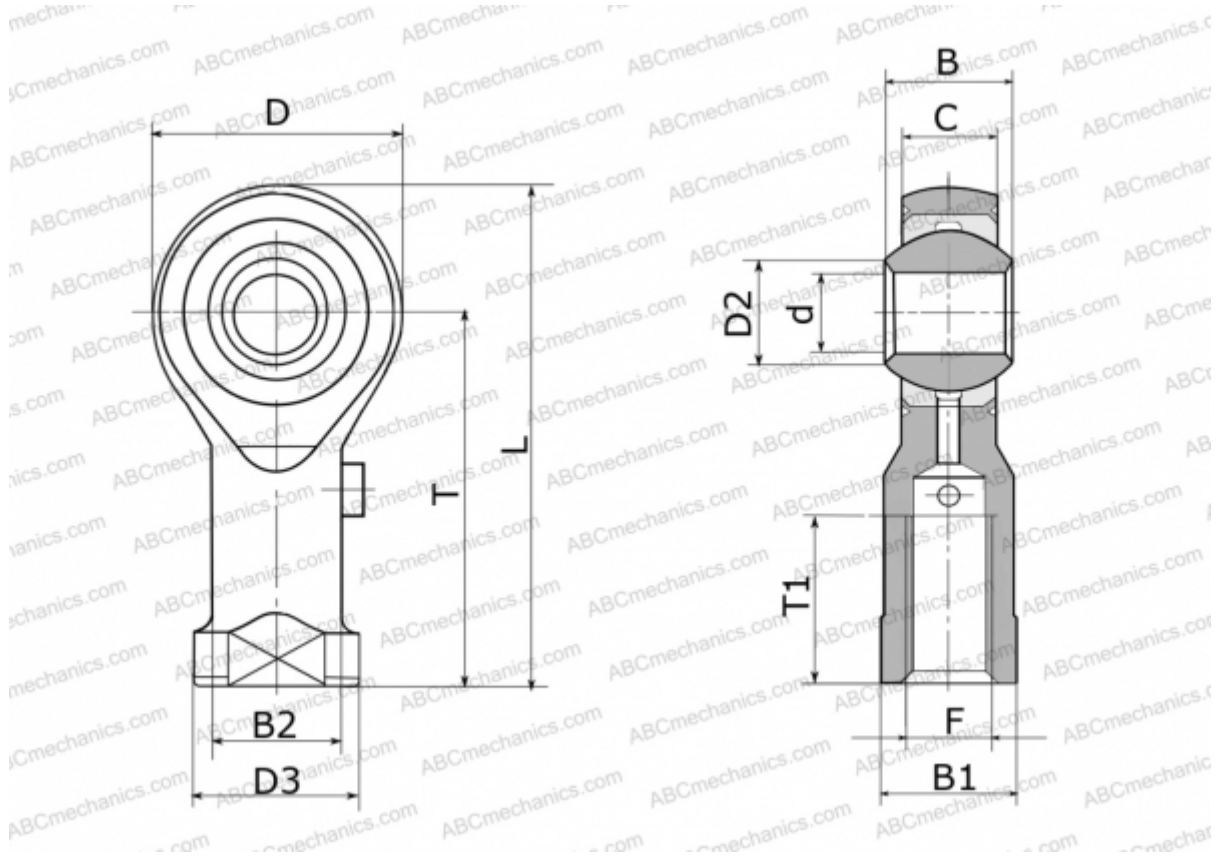

Technical specification

DIMENSIONS, MM

d	22,000
D	54,000
D2	25,800
D3	37,000
B	28,000
B1	32,000
B2	30,000
L	111,000
T	84,000
T1	37,000
C	20,000
F	M 22x1.5

MANUFACTURER

[FLURO](#)

WEIGHT, KG

0,540