

GA 8 FLURO

TYPE: Plain bearings, Spherical plain bearings and rod ends, Rod ends, Requiring maintenance, With external thread, open design, right hand thread, series GA (FLURO)

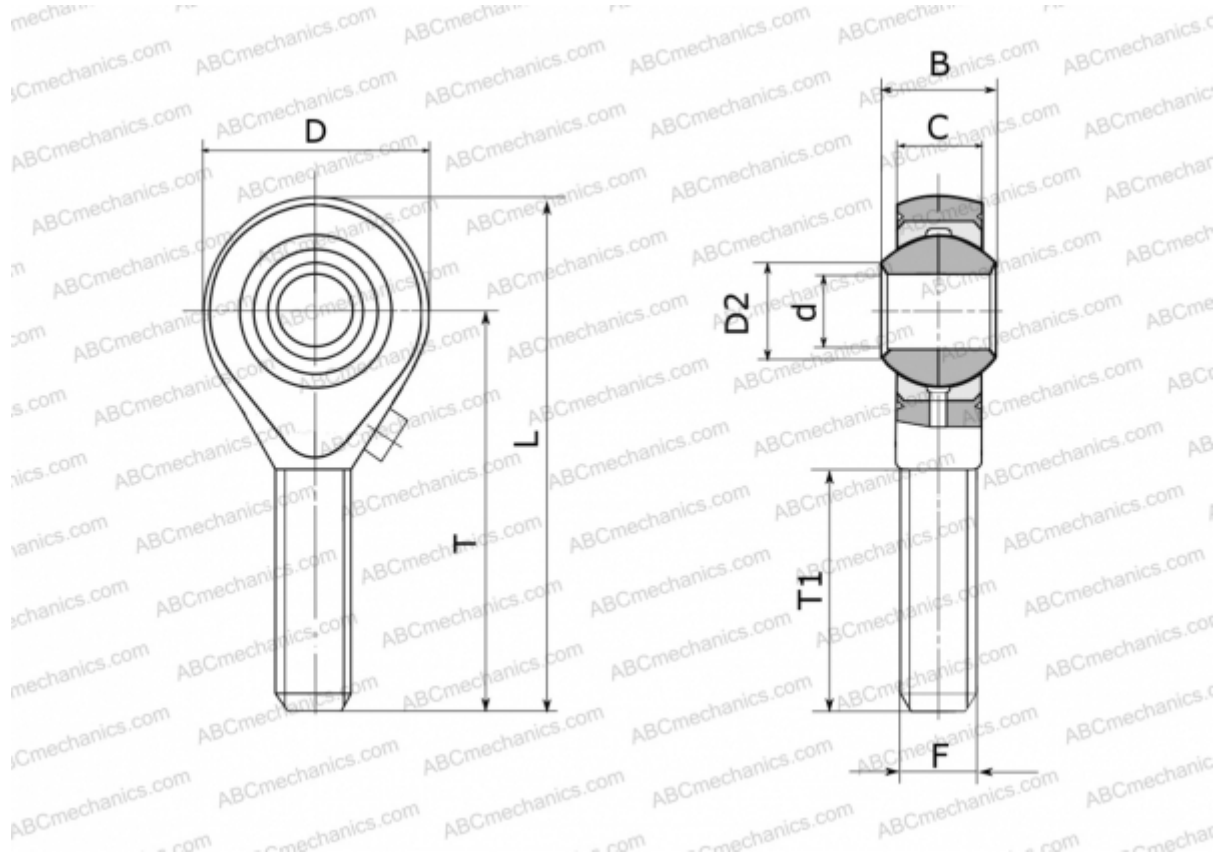

Technical specification

DIMENSIONS, MM

d	8,000
D	24,000
D2	10,400
B	12,000
L	54,000
T	42,000
T1	25,000
C	9,000
F	M 8

MANUFACTURER

[FLURO](#)