

GIS 2 FLURO

TYPE: Plain bearings, Spherical plain bearings and rod ends, Rod ends, Requiring maintenance, With internal thread, open design, right hand thread, series GIS (FLURO)

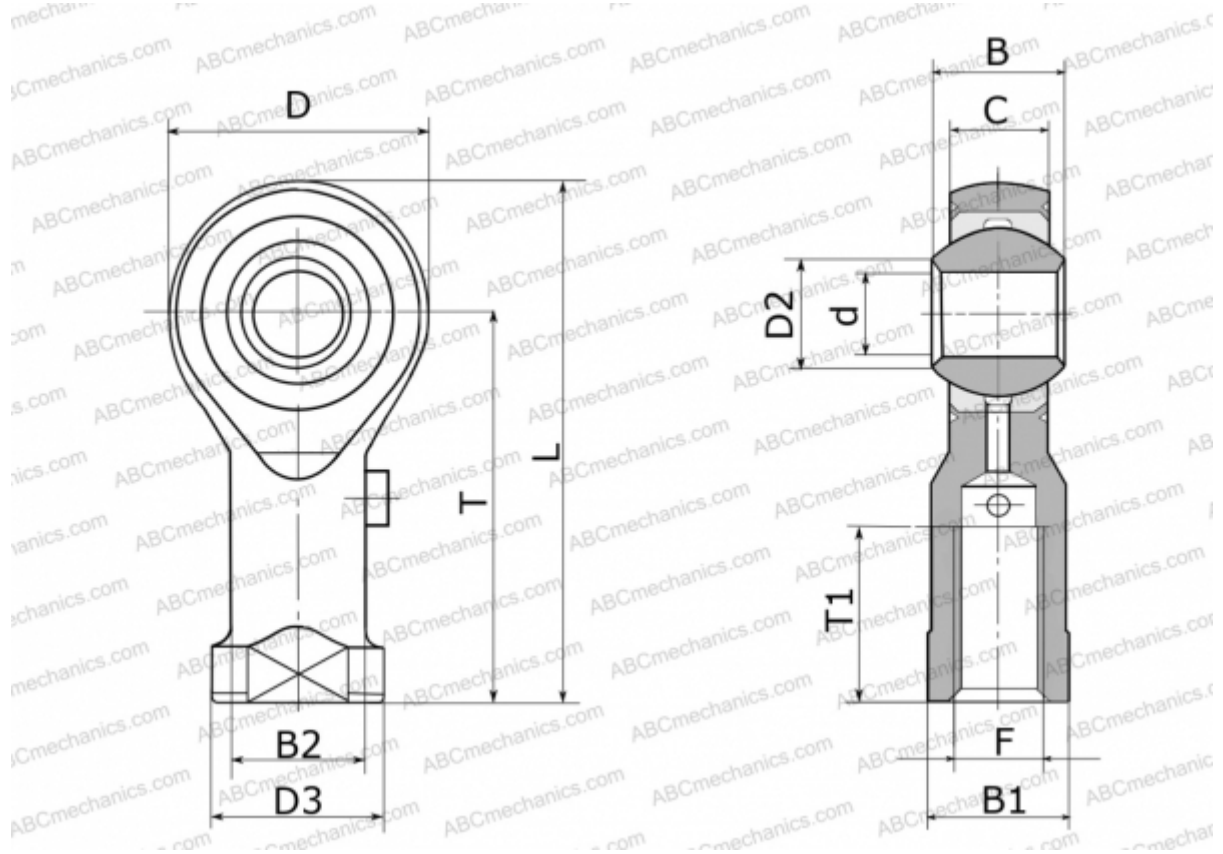

Technical specification

DIMENSIONS, MM

d	2,000
D	9,000
D2	2,600
D3	4,500
B	4,500
B1	4,000
B2	3,800
L	20,500
T	16,000
T1	7,000
C	3,600
F	M 2

MANUFACTURER

[FLURO](#)