

## GIS 3 FLURO

TYPE: Plain bearings, Spherical plain bearings and rod ends, Rod ends, Requiring maintenance, With internal thread, open design, right hand thread, series GIS (FLURO)

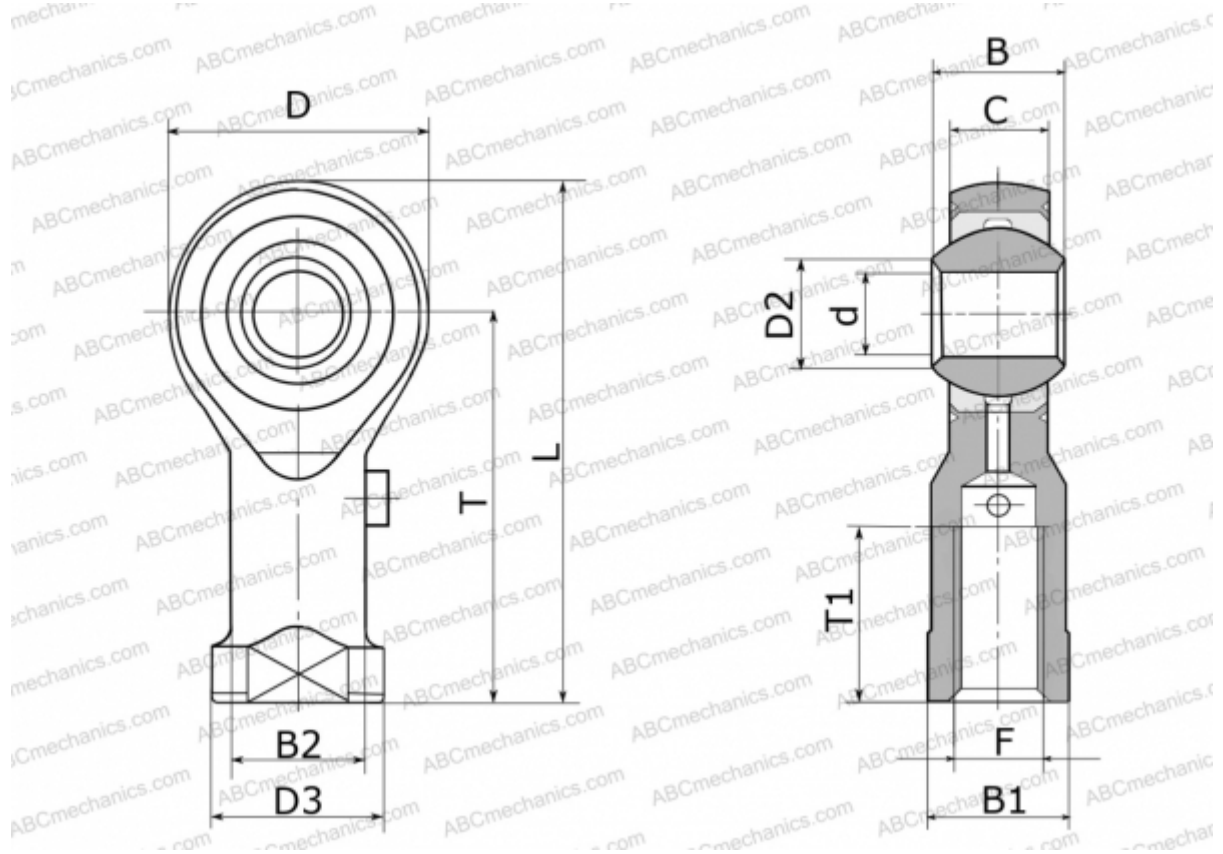

### Technical specification

#### DIMENSIONS, MM

d	3,000
D	14,000
D2	5,100
D3	6,500
B	6,000
B1	5,500
B2	5,000
L	27,000
T	21,000
T1	10,000
C	4,500
F	M 3

#### MANUFACTURER

[FLURO](#)