

GIS 8 FLURO

TYPE: Plain bearings, Spherical plain bearings and rod ends, Rod ends, Requiring maintenance, With internal thread, open design, right hand thread, series GIS (FLURO)

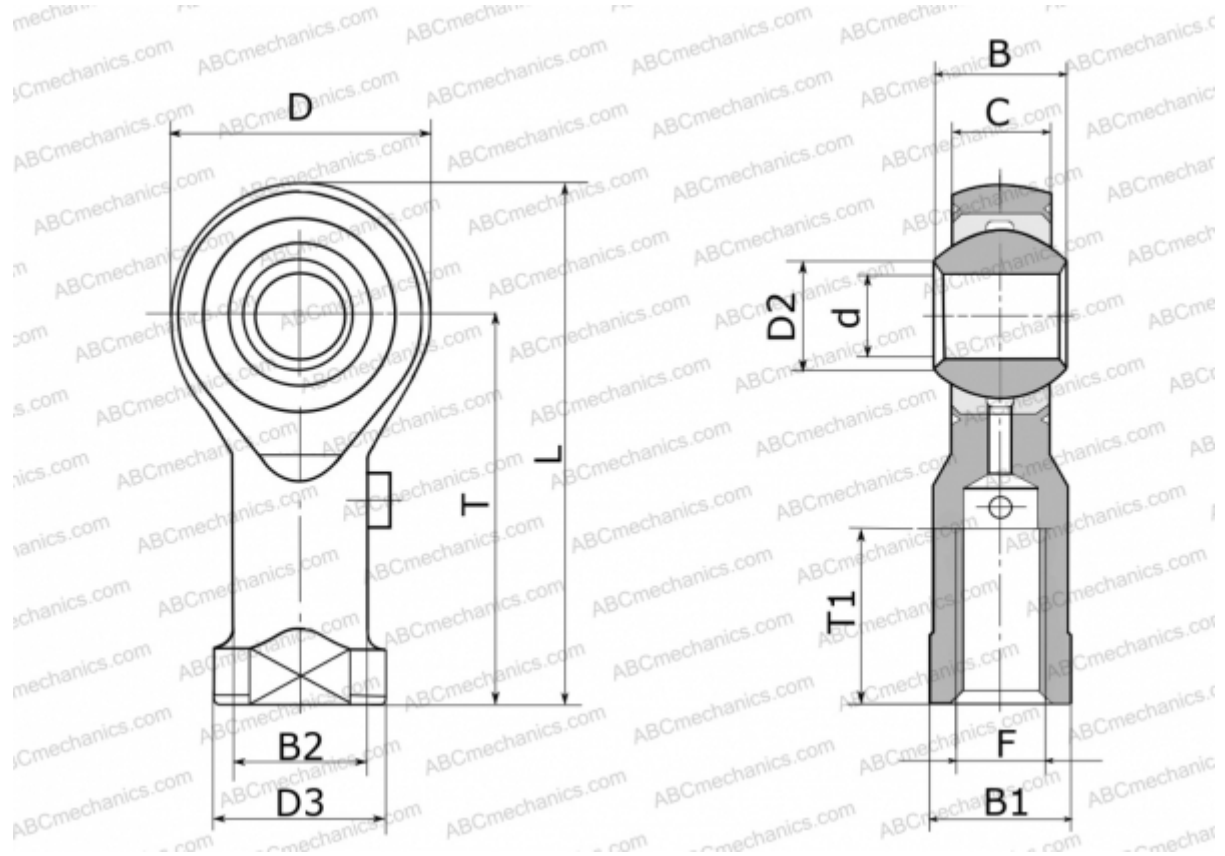

Technical specification

DIMENSIONS, MM

d	8,000
D	24,000
D2	10,400
D3	16,000
B	12,000
B1	13,000
B2	12,500
L	48,000
T	36,000
T1	16,000
C	9,000
F	M 8

MANUFACTURER

[FLURO](#)