

GAS 16 FLURO

TYPE: Plain bearings, Spherical plain bearings and rod ends, Rod ends, Requiring maintenance, With external thread, open design, right hand thread, series GAS (FLURO)

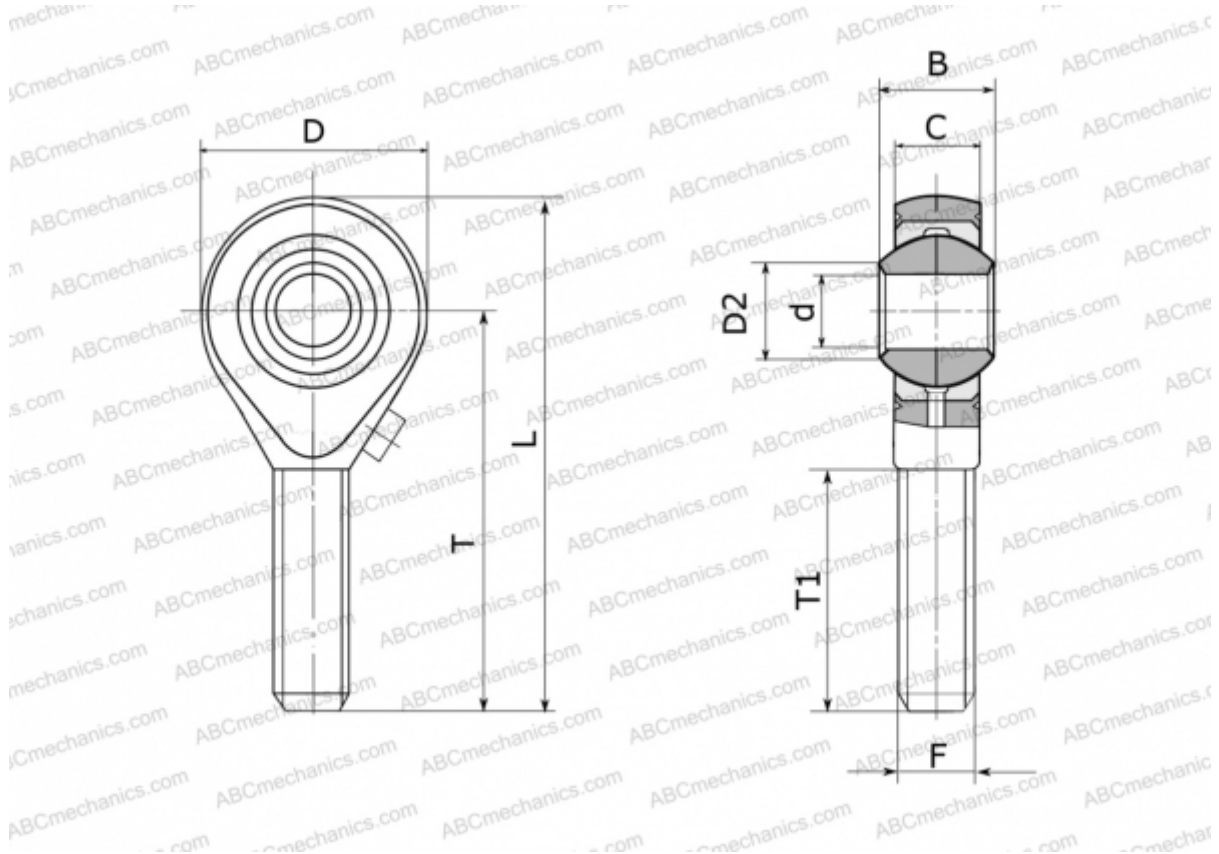

Technical specification

DIMENSIONS, MM

d	16,000
D	42,000
D2	19,300
B	21,000
L	87,000
T	66,000
T1	40,000
C	15,000
F	M 16

WEIGHT, KG 0,189

MANUFACTURER [FLURO](#)