

GAS 30 FLURO

TYPE: Plain bearings, Spherical plain bearings and rod ends, Rod ends, Requiring maintenance, With external thread, open design, right hand thread, series GAS (FLURO)

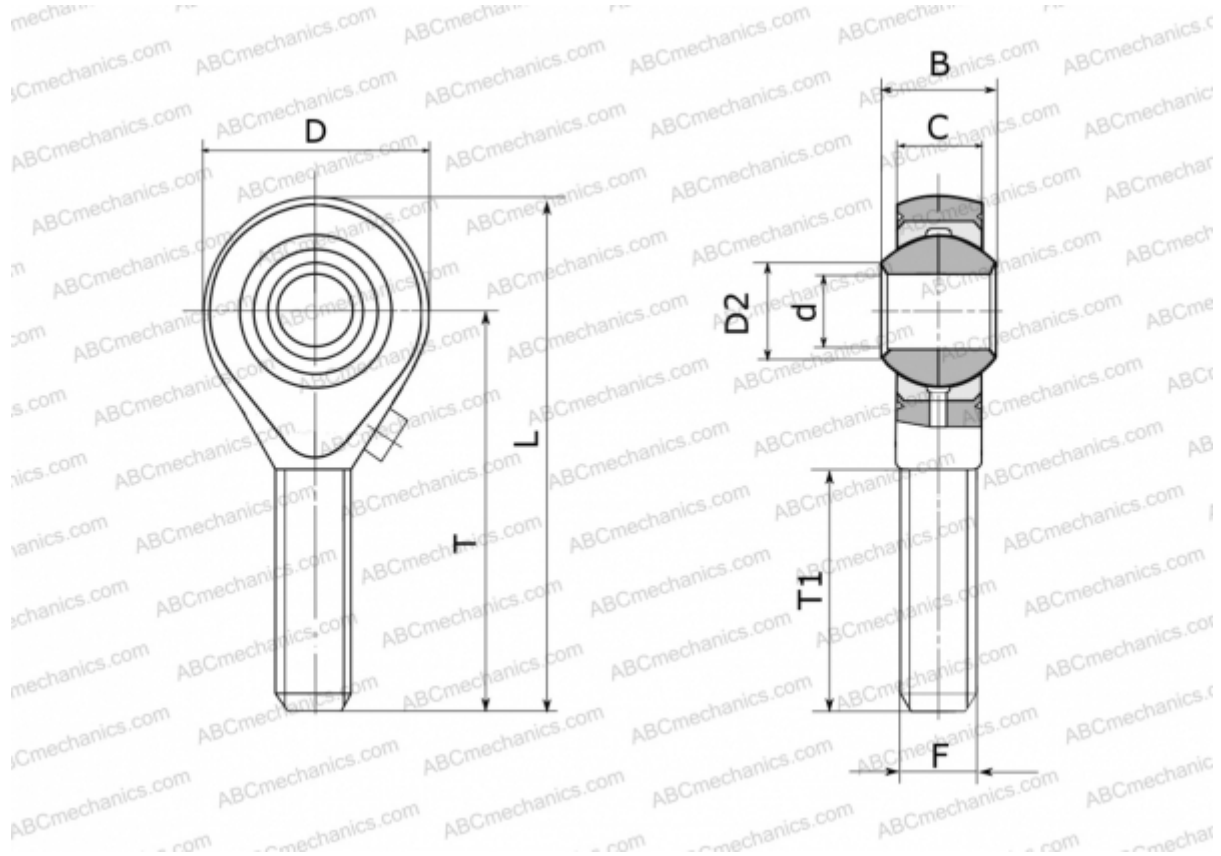

Technical specification

DIMENSIONS, MM

d	30,000
D	70,000
D2	34,800
B	37,000
L	145,000
T	110,000
T1	71,000
C	25,000
F	M 30x2

WEIGHT, KG 1,030

MANUFACTURER [FLURO](#)