

GILXS 6 FLURO

TYPE: Plain bearings, Spherical plain bearings and rod ends, Rod ends, Requiring maintenance, With internal thread, open design, left hand thread, series GILXS (FLURO)

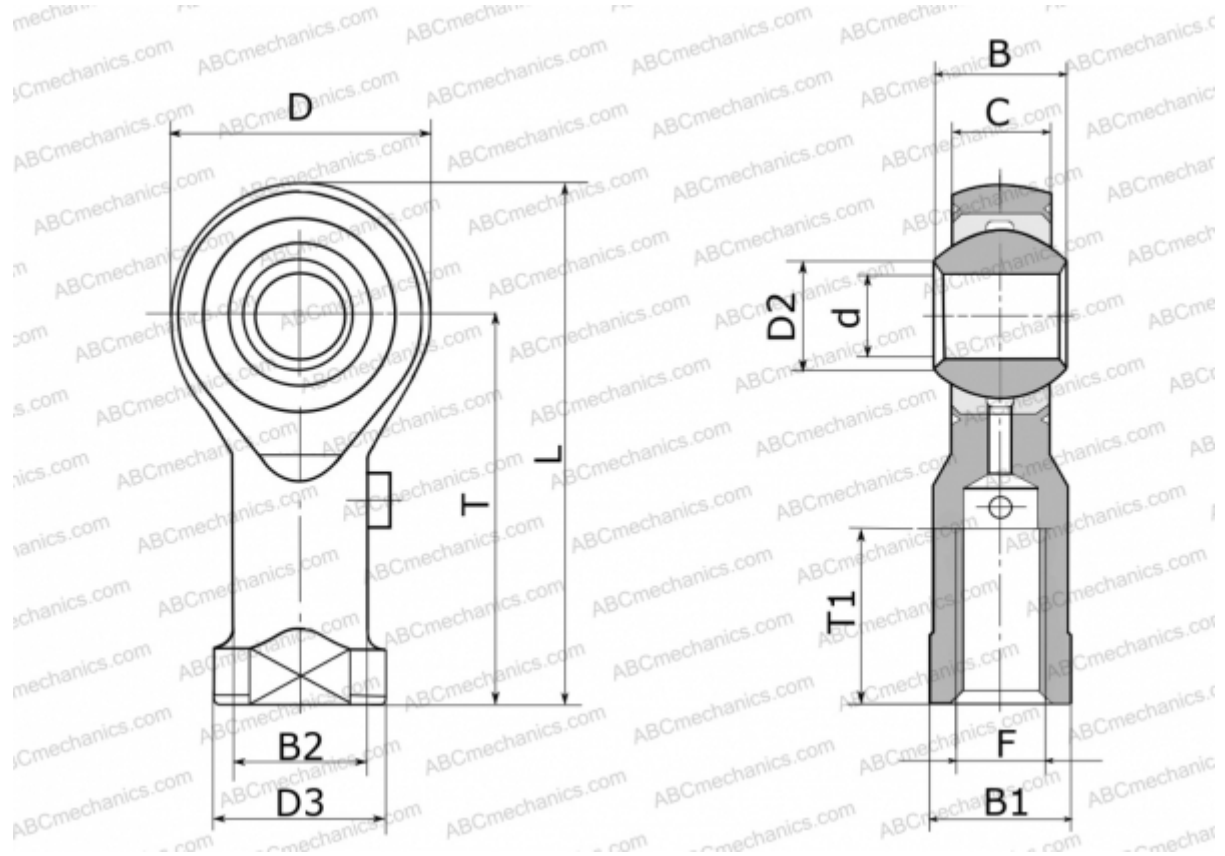

Technical specification

DIMENSIONS, MM

| | |
|----|--------|
| d | 6,000 |
| D | 20,000 |
| D2 | 8,900 |
| D3 | 13,000 |
| B | 9,000 |
| B1 | 11,000 |
| B2 | 10,000 |
| L | 40,000 |
| T | 30,000 |
| T1 | 12,000 |
| C | 6,750 |
| F | M 6 |

MANUFACTURER

[FLURO](#)

WEIGHT, KG

0,027