

GARS 3 FLURO

TYPE: Plain bearings, Spherical plain bearings and rod ends, Rod ends, Requiring maintenance, With external thread, open design, right hand thread, stainless steel, series GARS (FLURO)

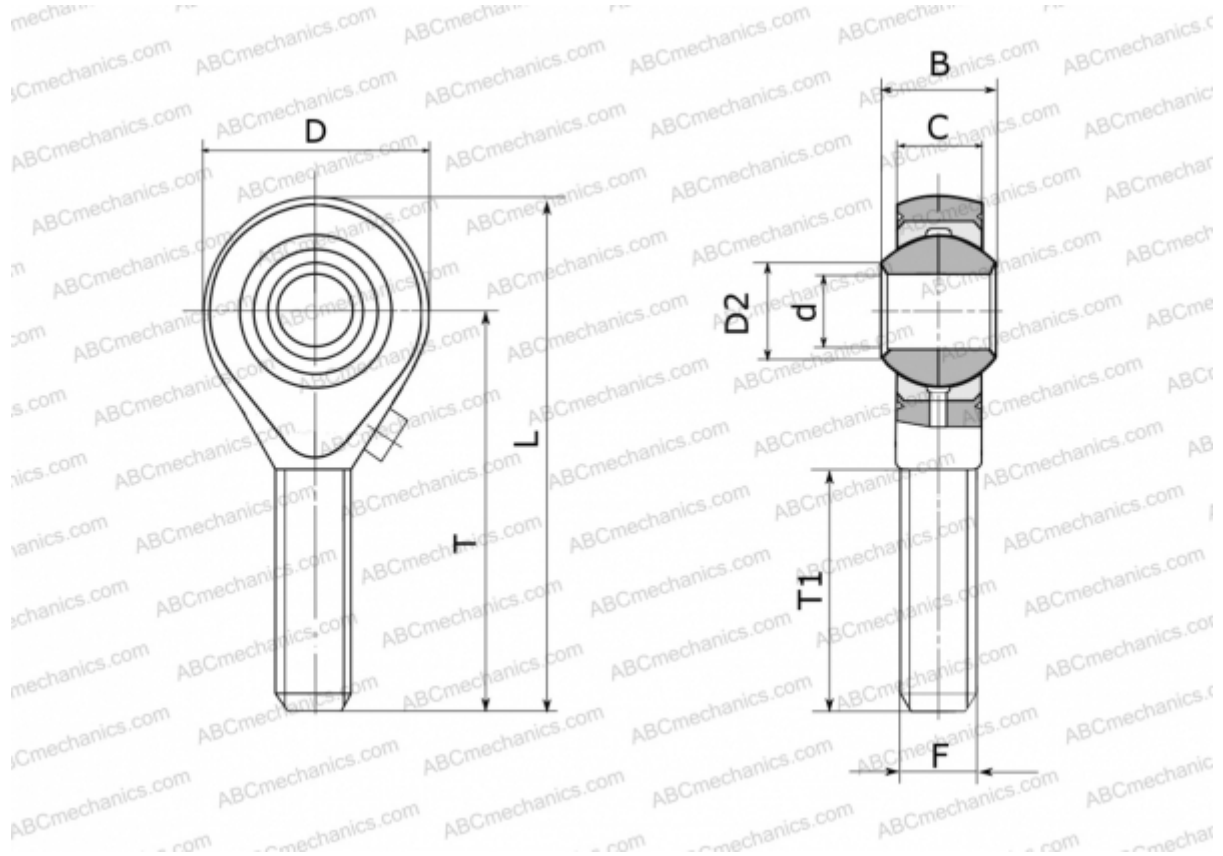

Technical specification

DIMENSIONS, MM

d	3,000
D	14,000
D2	5,100
B	6,000
L	33,000
T	26,000
T1	15,000
C	4,500
F	M 3

WEIGHT, KG 0,006

MANUFACTURER [FLURO](#)