

GF20-DO ELGES

TYPE: Plain bearings, Spherical plain bearings and rod ends, Rod ends, Hydraulic, Requiring maintenance, with rectangular welding face, open design, series GF..-DO (INA)

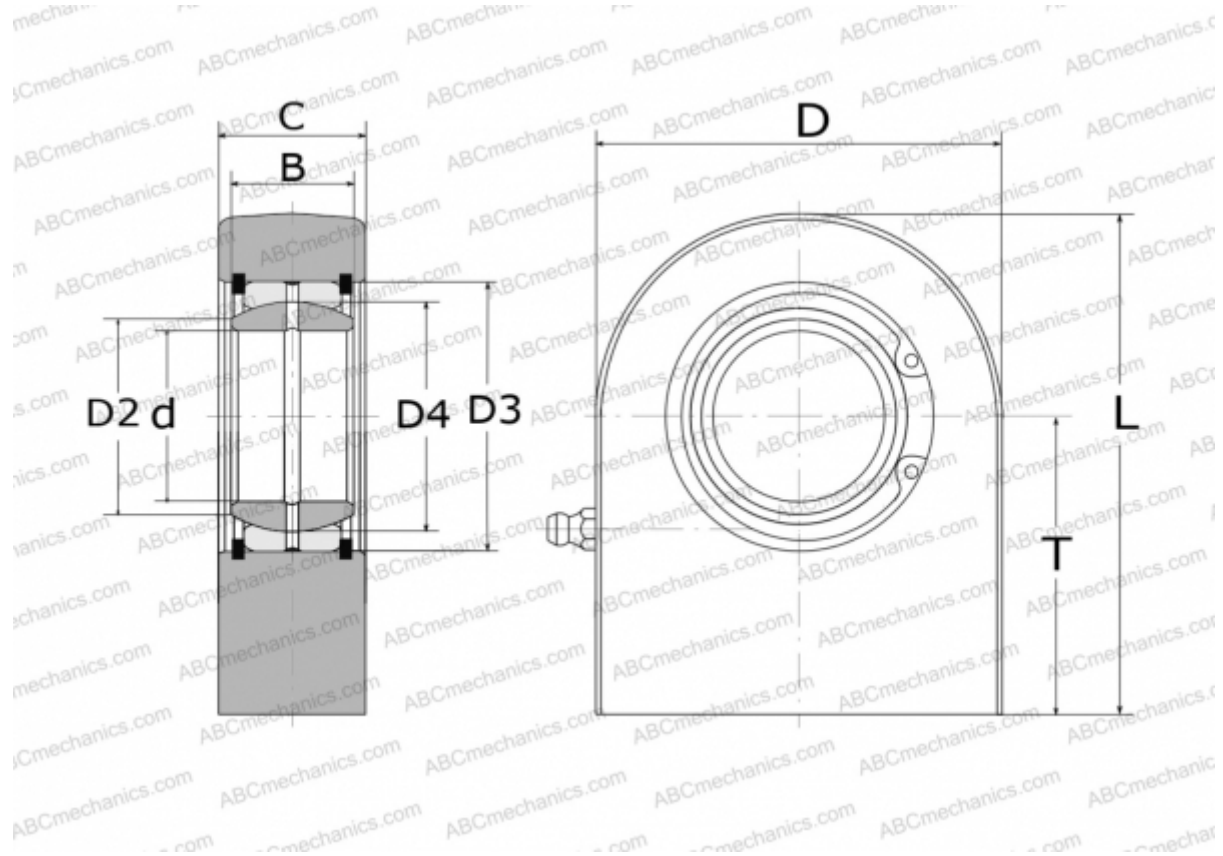

Technical specification

DIMENSIONS, MM

d	20,000
D	50,000
D2	24,200
D3	35,000
D4	29,000
B	16,000
L	63,000
T	38,000
C	19,000

WEIGHT, KG 0,350

MANUFACTURER [ELGES](#)