

GF40-DO ELGES

TYPE: Plain bearings, Spherical plain bearings and rod ends, Rod ends, Hydraulic, Requiring maintenance, with rectangular welding face, open design, series GF..-DO (INA)

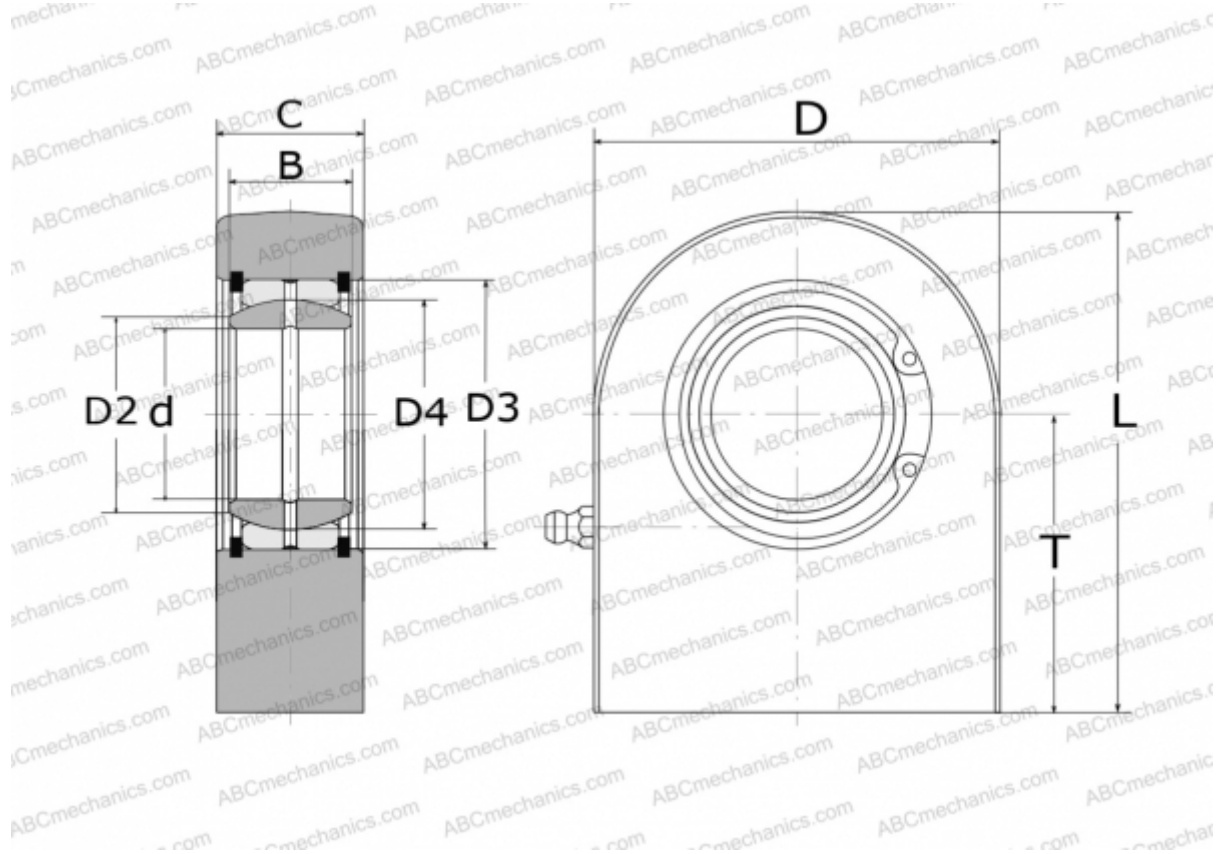

Technical specification

DIMENSIONS, MM

d	40,000
D	100,000
D2	45,000
D3	62,000
D4	53,000
B	28,000
L	119,000
T	69,000
C	35,000

WEIGHT, KG 2,400

MANUFACTURER [ELGES](#)