

## GF50-DO ELGES

TYPE: Plain bearings, Spherical plain bearings and rod ends, Rod ends, Hydraulic, Requiring maintenance, with rectangular welding face, open design, series GF..-DO (INA)

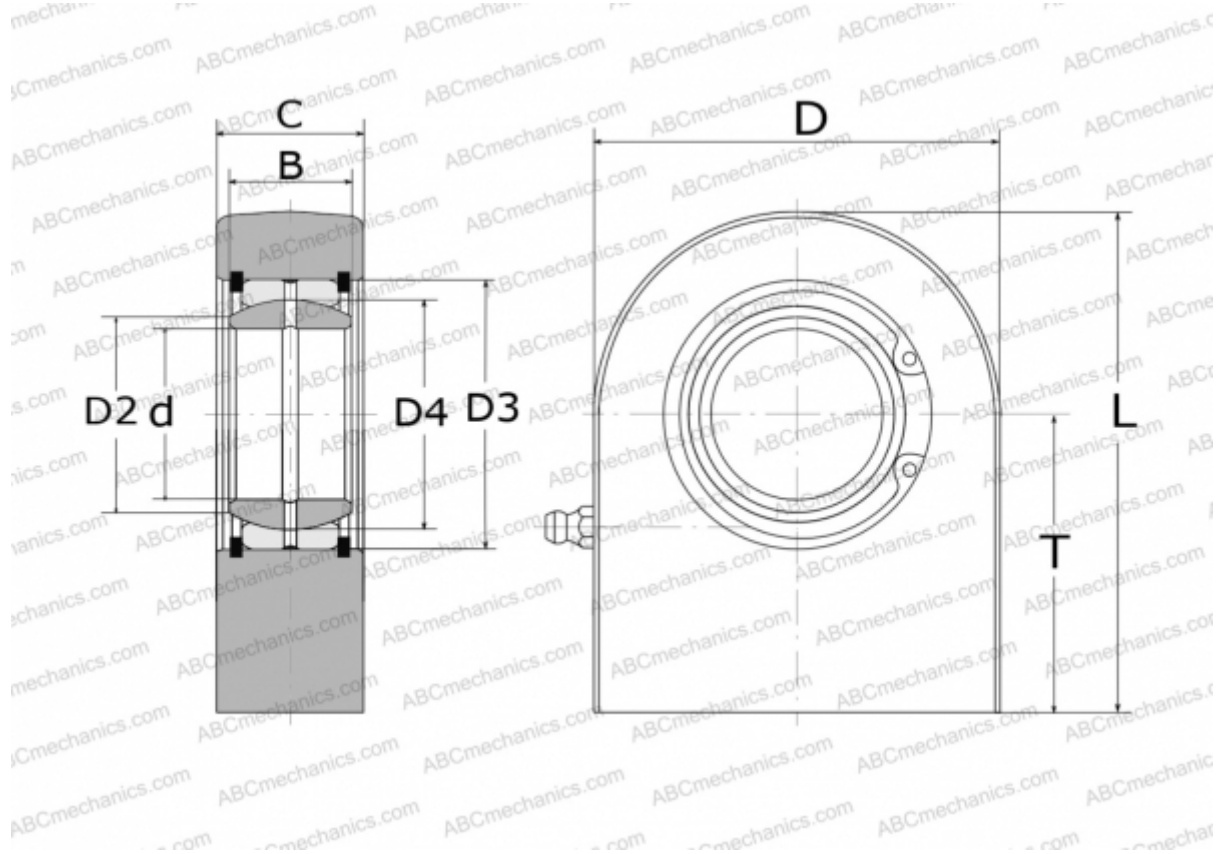

### Technical specification

#### DIMENSIONS, MM

d	50,000
D	123,000
D2	56,000
D3	75,000
D4	66,000
B	35,000
L	149,500
T	88,000
C	40,000

**WEIGHT, KG** 4,400

**MANUFACTURER** [ELGES](#)