

GF70-DO ELGES

TYPE: Plain bearings, Spherical plain bearings and rod ends, Rod ends, Hydraulic, Requiring maintenance, with rectangular welding face, open design, series GF..-DO (INA)

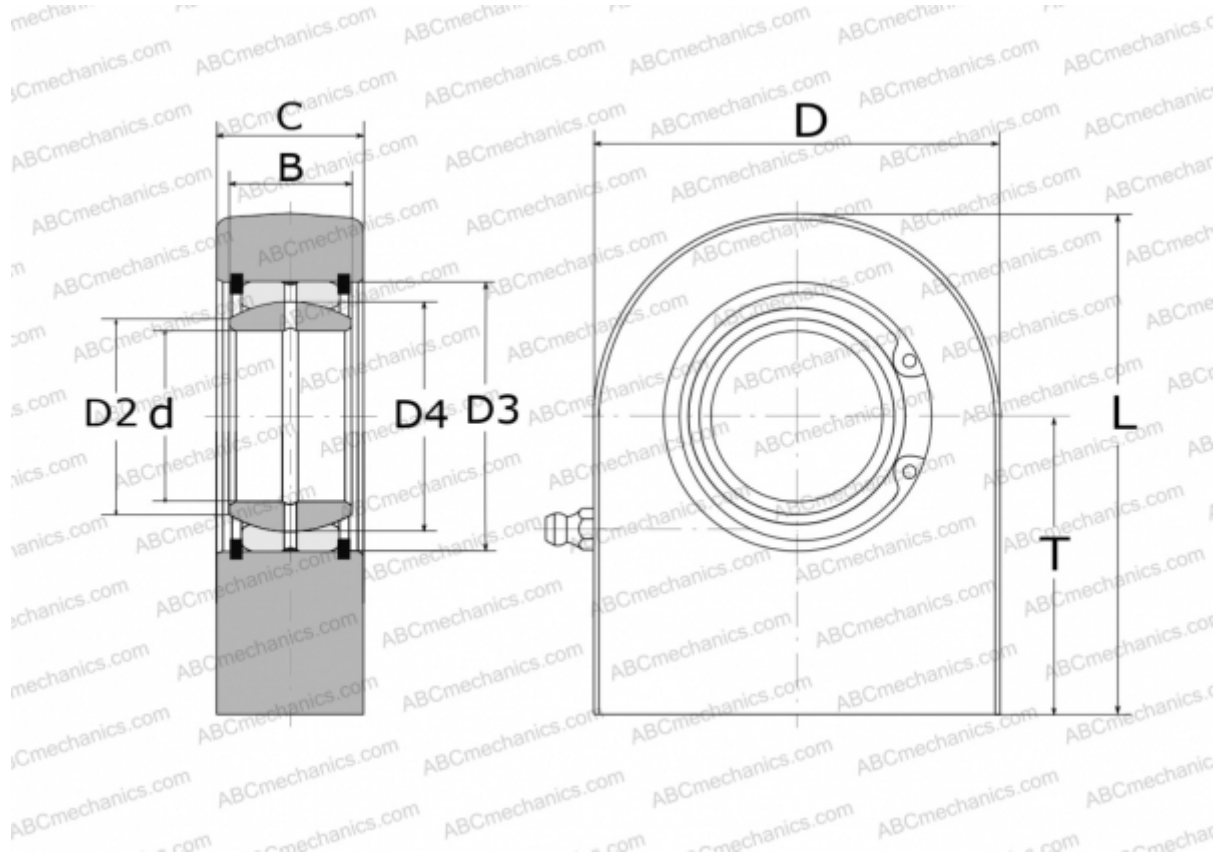

Technical specification

DIMENSIONS, MM

d	70,000
D	164,000
D2	77,900
D3	105,000
D4	92,000
B	49,000
L	197,000
T	115,000
C	55,000

WEIGHT, KG 10,500

MANUFACTURER [ELGES](#)