

EGB0305-E40 INA

Plain bushes

TYPE: Plain bearings, Bushings, thrust washers and strips, Bushings, Without flange, Maintenance-free, with steel backing (INA)

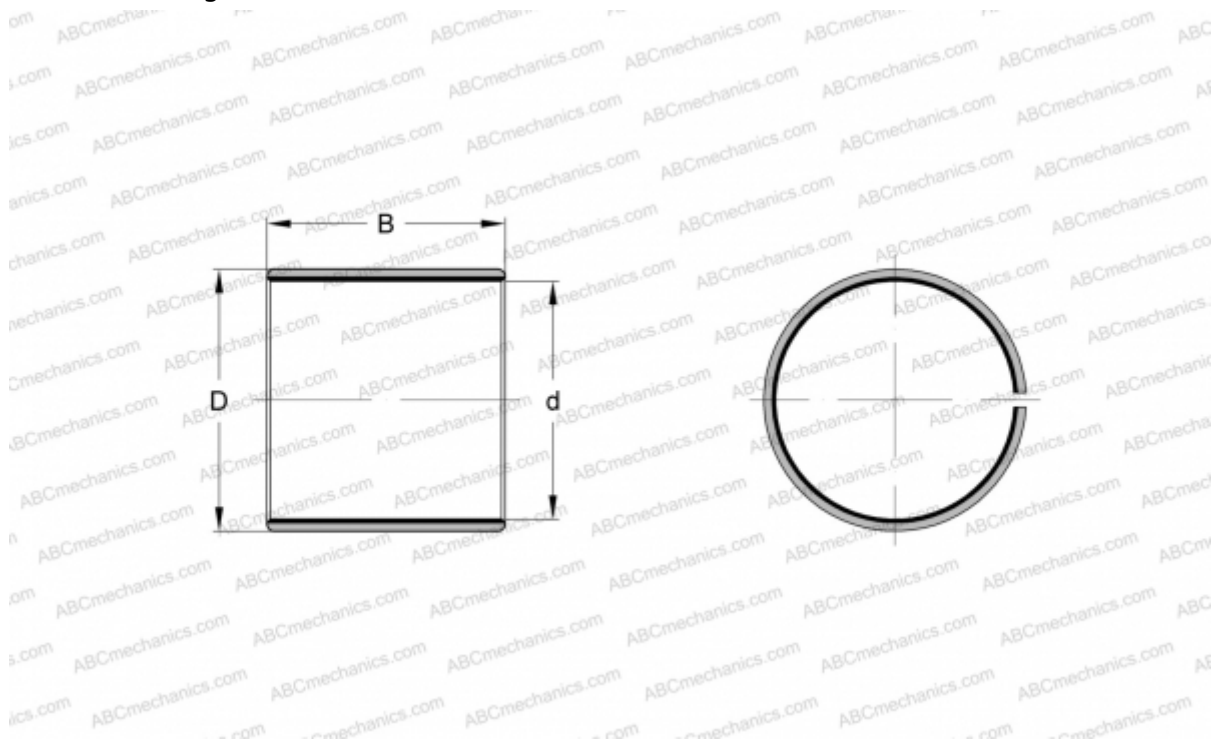

Technical specification

DIMENSIONS, MM

d	3,000
D	4,500
B	5,000

WEIGHT, KG 0,001

MANUFACTURER [INA](#)

REPLACES

PAP0305-P14