

EGB0406-E40 INA

Plain bushes

TYPE: Plain bearings, Bushings, thrust washers and strips, Bushings, Without flange, Maintenance-free, with steel backing (INA)

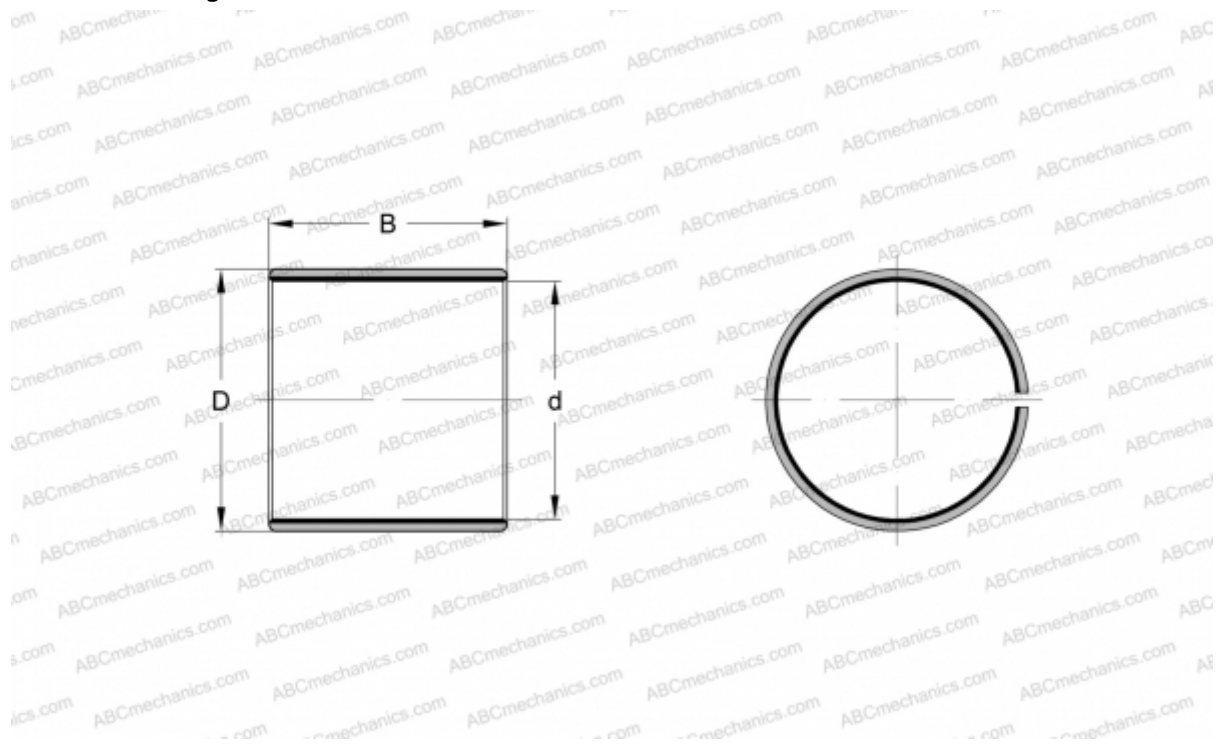

Technical specification

DIMENSIONS, MM

d	4,000
D	5,500
B	6,000

WEIGHT, KG 0,001

MANUFACTURER [INA](#)

REPLACES

PAP0406-P14