

EGB0510-E40 INA

Plain bushes

TYPE: Plain bearings, Bushings, thrust washers and strips, Bushings, Without flange, Maintenance-free, with steel backing (INA)

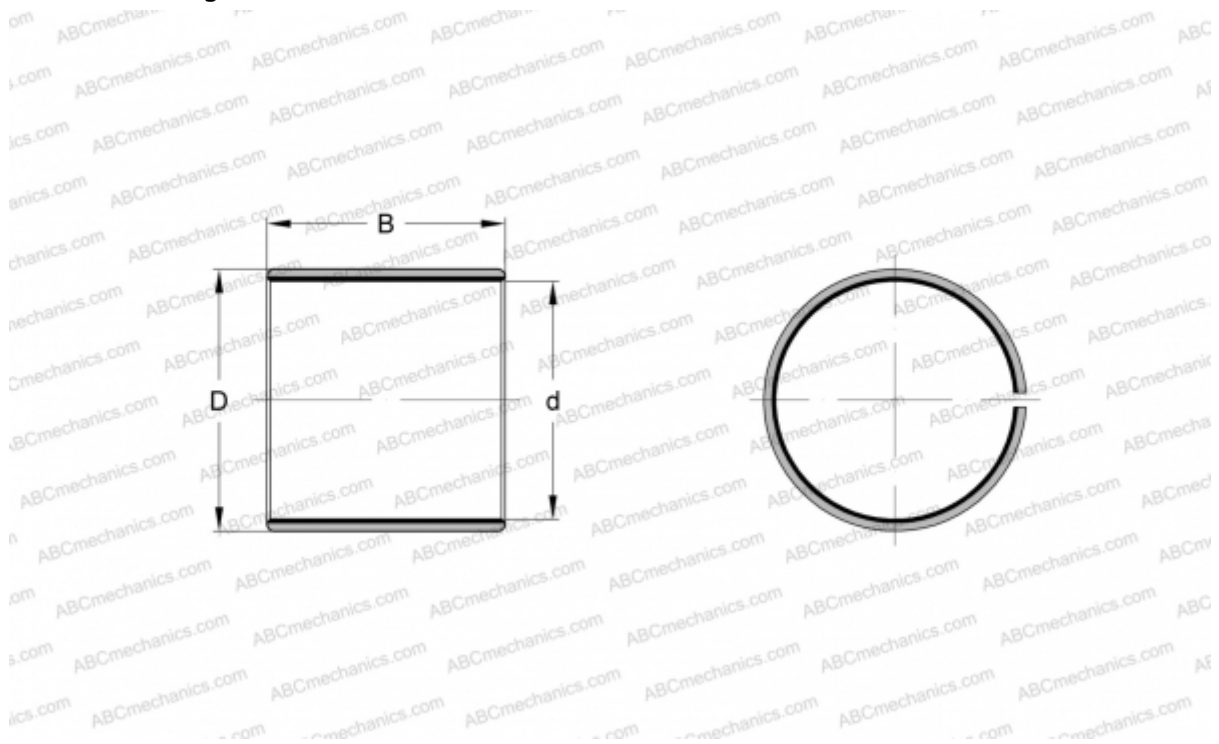

Technical specification

DIMENSIONS, MM

d	5,000
D	7,000
B	10,000

WEIGHT, KG 0,001

MANUFACTURER [INA](#)

REPLACES

PAP0510-P14