

## EGB0606-E40 INA

Plain bushes

TYPE: Plain bearings, Bushings, thrust washers and strips, Bushings, Without flange, Maintenance-free, with steel backing (INA)

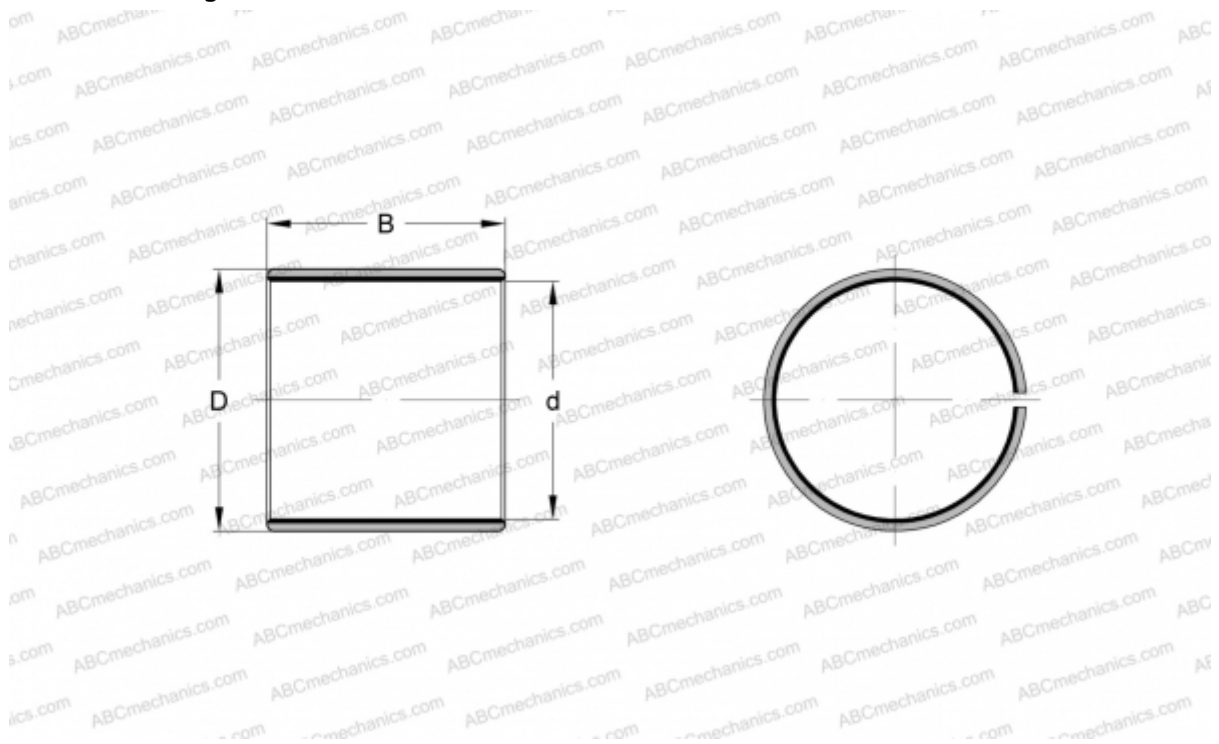

### Technical specification

#### DIMENSIONS, MM

d	6,000
D	8,000
B	6,000

**WEIGHT, KG** 0,001

**MANUFACTURER** [INA](#)

#### REPLACES

PAP0606-P14