

EGB0710-E40 INA

Plain bushes

TYPE: Plain bearings, Bushings, thrust washers and strips, Bushings, Without flange, Maintenance-free, with steel backing (INA)

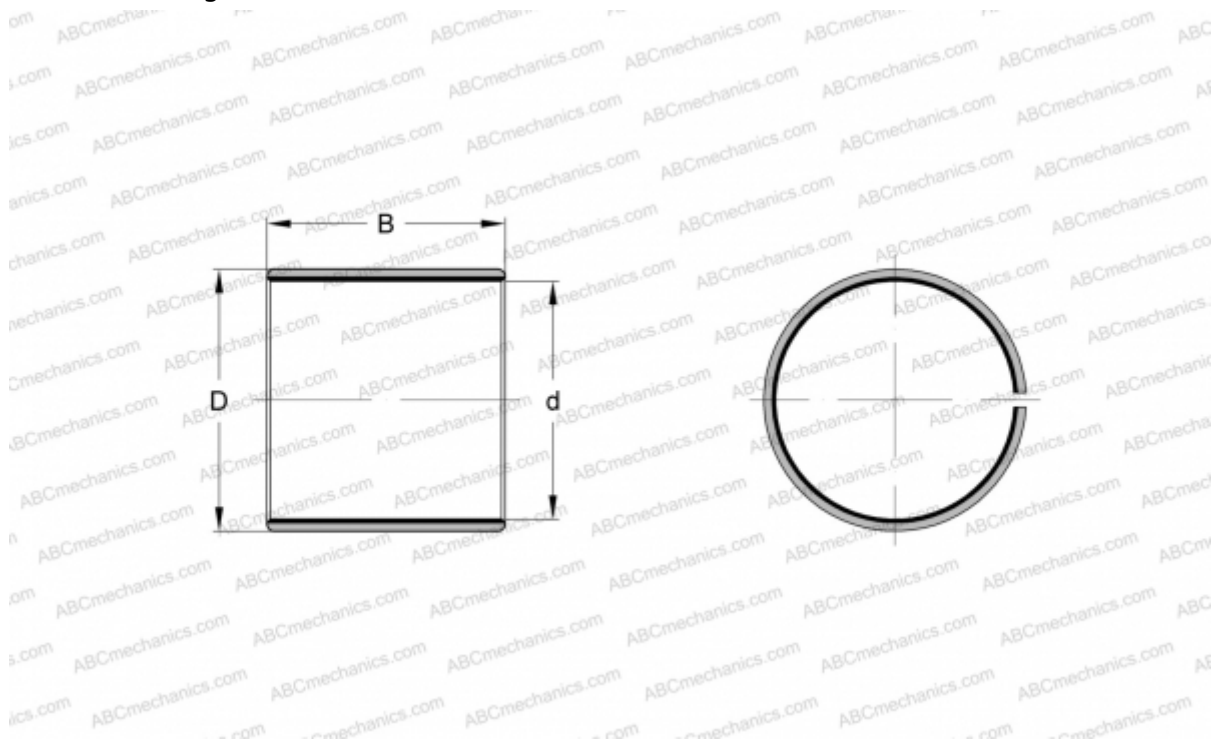

Technical specification

DIMENSIONS, MM

| | |
|---|--------|
| d | 7,000 |
| D | 9,000 |
| B | 10,000 |

WEIGHT, KG 0,002

MANUFACTURER [INA](#)

REPLACES

PAP0710-P14