

EGB0806-E40 INA

Plain bushes

TYPE: Plain bearings, Bushings, thrust washers and strips, Bushings, Without flange, Maintenance-free, with steel backing (INA)

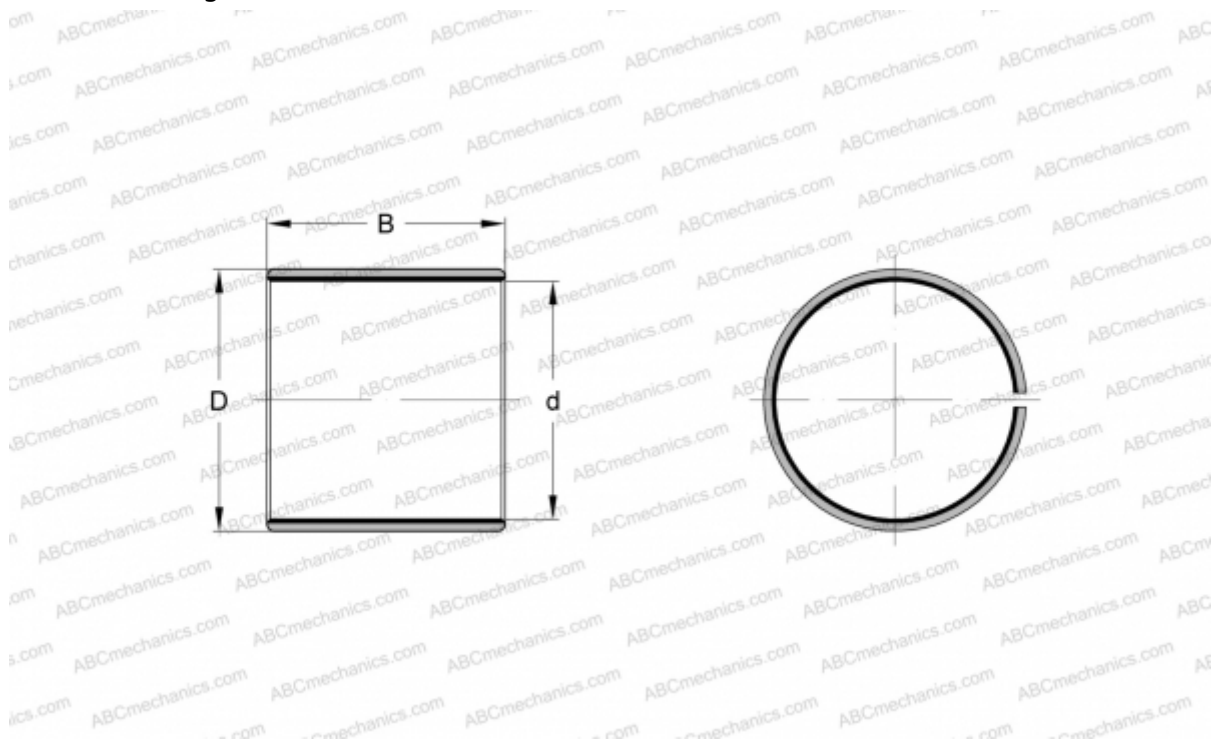

Technical specification

DIMENSIONS, MM

d	8,000
D	10,000
B	6,000

WEIGHT, KG 0,001

MANUFACTURER [INA](#)

REPLACES

PAP0806-P14