

EGB1008-E40 INA

Plain bushes

TYPE: Plain bearings, Bushings, thrust washers and strips, Bushings, Without flange, Maintenance-free, with steel backing (INA)

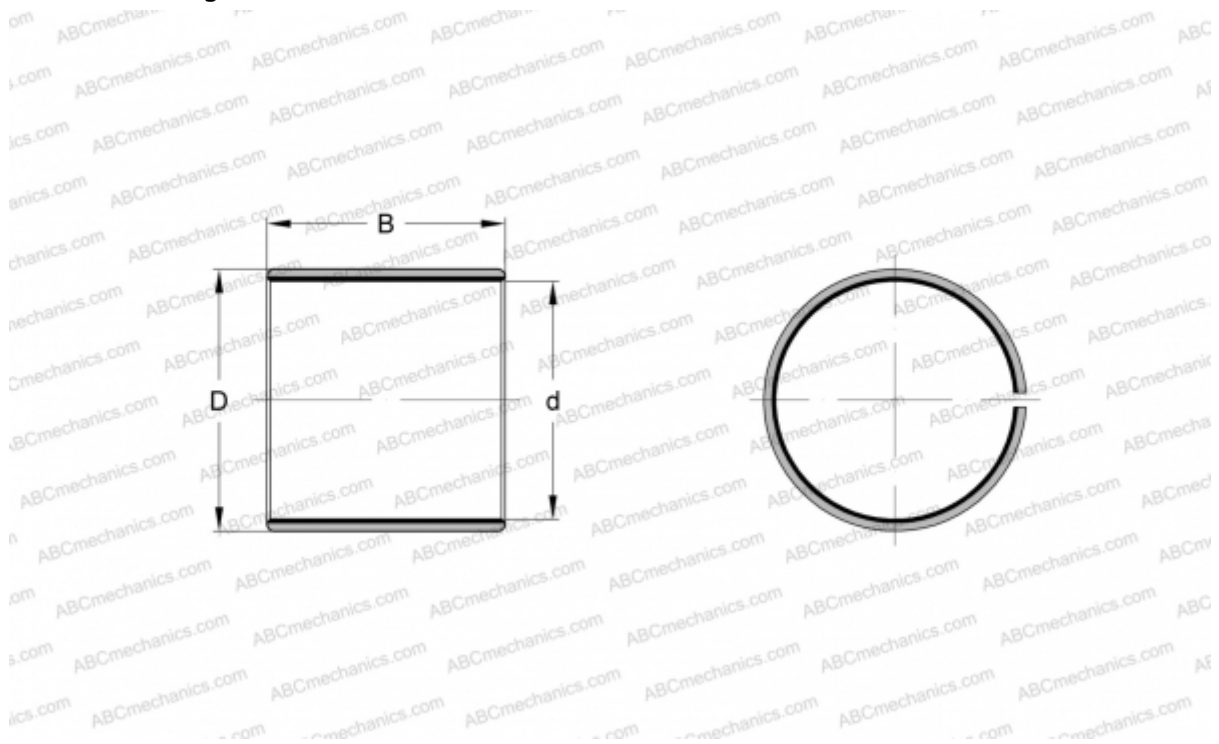

Technical specification

DIMENSIONS, MM

d	10,000
D	12,000
B	8,000

WEIGHT, KG 0,002

MANUFACTURER [INA](#)

REPLACES

PAP1008-P14