

EGB1208-E40 INA

Plain bushes

TYPE: Plain bearings, Bushings, thrust washers and strips, Bushings, Without flange, Maintenance-free, with steel backing (INA)

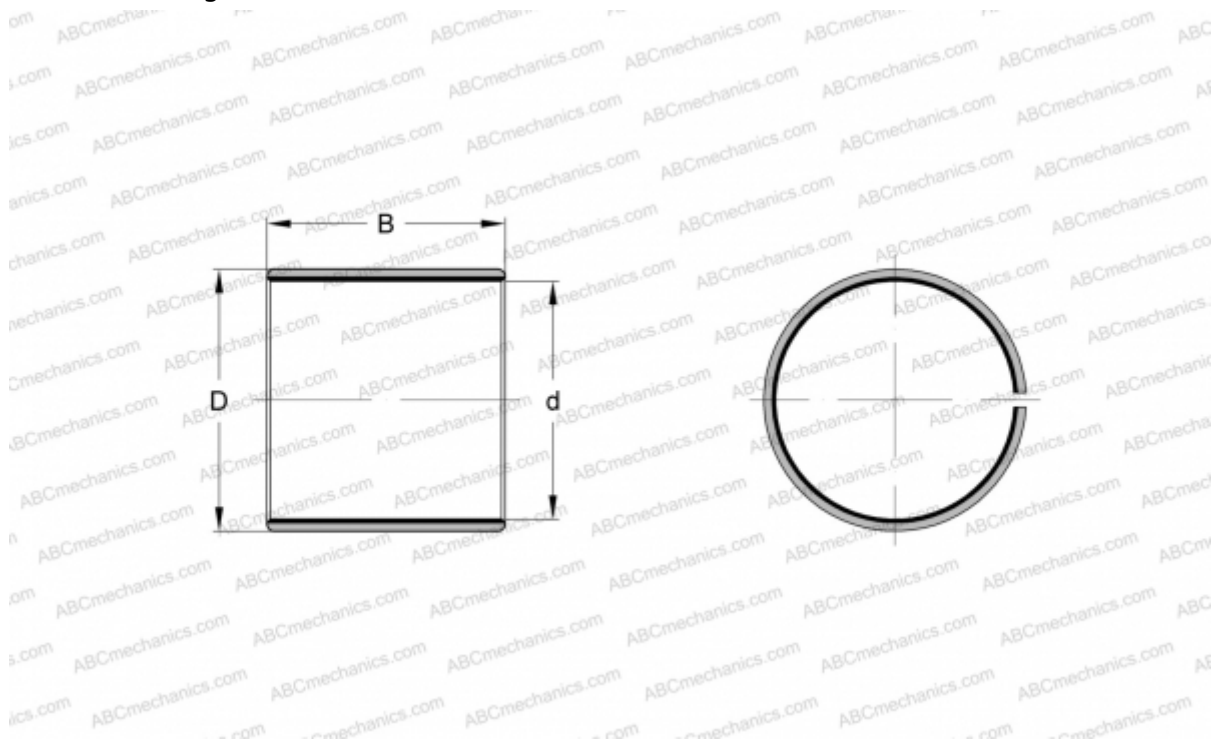

Technical specification

DIMENSIONS, MM

d	12,000
D	14,000
B	8,000

WEIGHT, KG 0,002

MANUFACTURER [INA](#)

REPLACES

PAP1208-P14