

EGB1515-E40 INA

Plain bushes

TYPE: Plain bearings, Bushings, thrust washers and strips, Bushings, Without flange, Maintenance-free, with steel backing (INA)

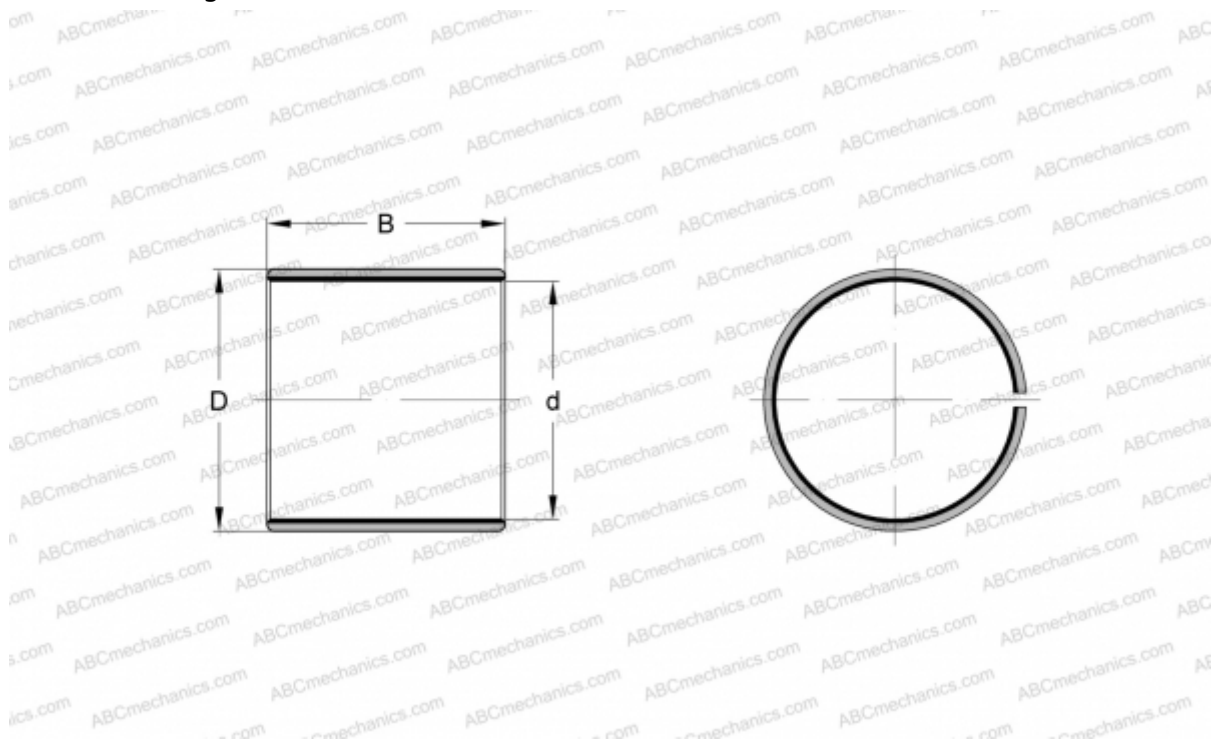

Technical specification

DIMENSIONS, MM

d	15,000
D	17,000
B	15,000

WEIGHT, KG 0,005

MANUFACTURER [INA](#)

REPLACES

PAP1515-P14