

## EGB1612-E40 INA

Plain bushes

TYPE: Plain bearings, Bushings, thrust washers and strips, Bushings, Without flange, Maintenance-free, with steel backing (INA)

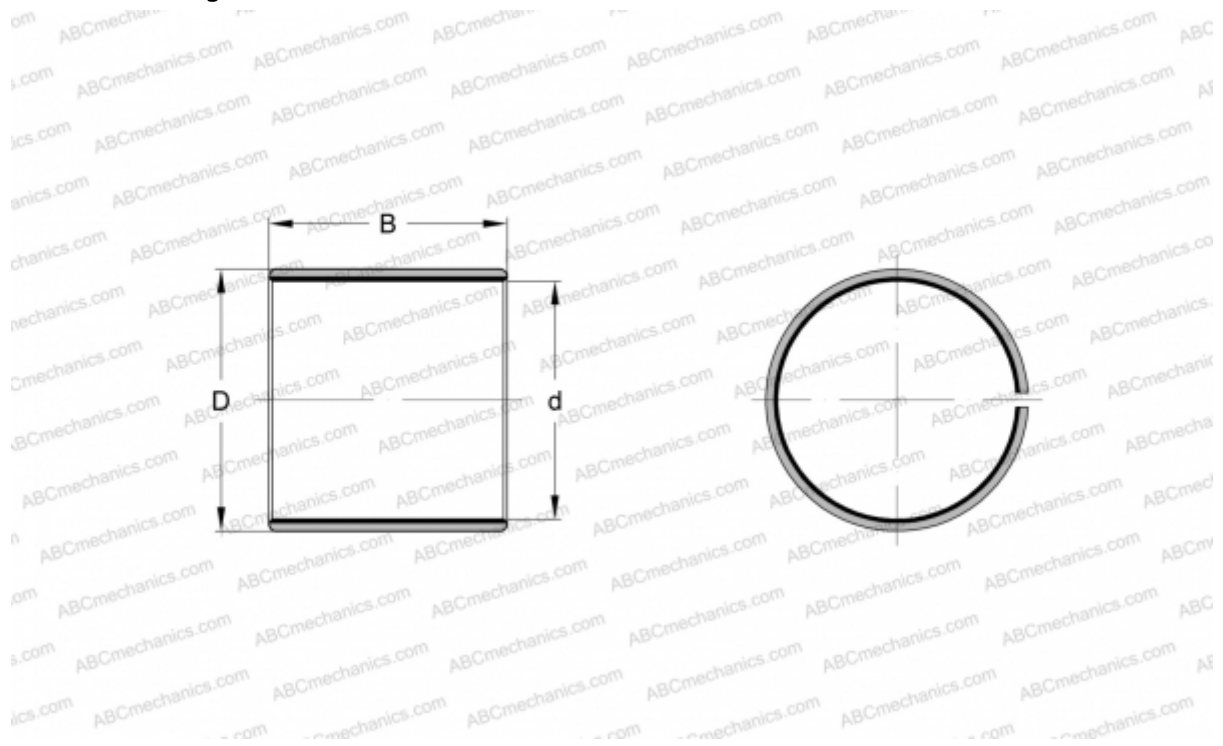

### Technical specification

#### DIMENSIONS, MM

d	16,000
D	18,000
B	12,000

**WEIGHT, KG** 0,005

**MANUFACTURER** [INA](#)

#### REPLACES

PAP1612-P14