

EGB1825-E40 INA

Plain bushes

TYPE: Plain bearings, Bushings, thrust washers and strips, Bushings, Without flange, Maintenance-free, with steel backing (INA)

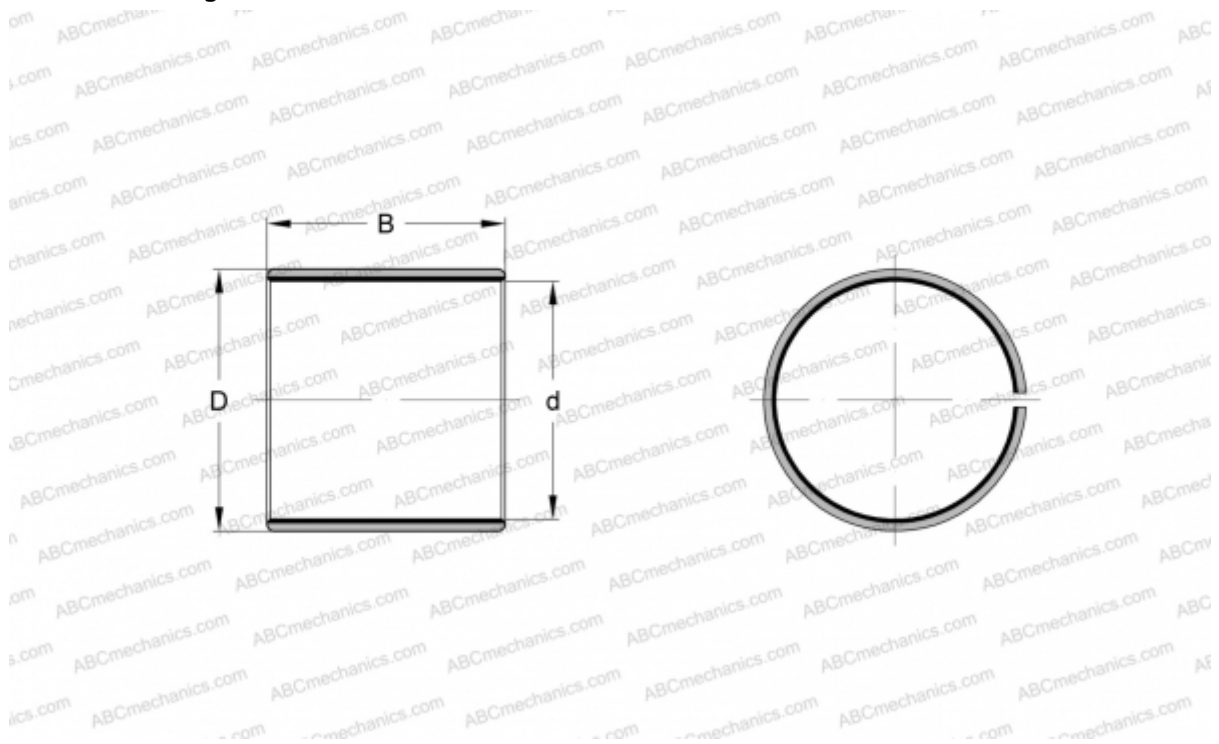

Technical specification

DIMENSIONS, MM

d	18,000
D	20,000
B	25,000

WEIGHT, KG 0,011

MANUFACTURER [INA](#)

REPLACES

PAP1825-P14