

EGB2015-E40 INA

Plain bushes

TYPE: Plain bearings, Bushings, thrust washers and strips, Bushings, Without flange, Maintenance-free, with steel backing (INA)

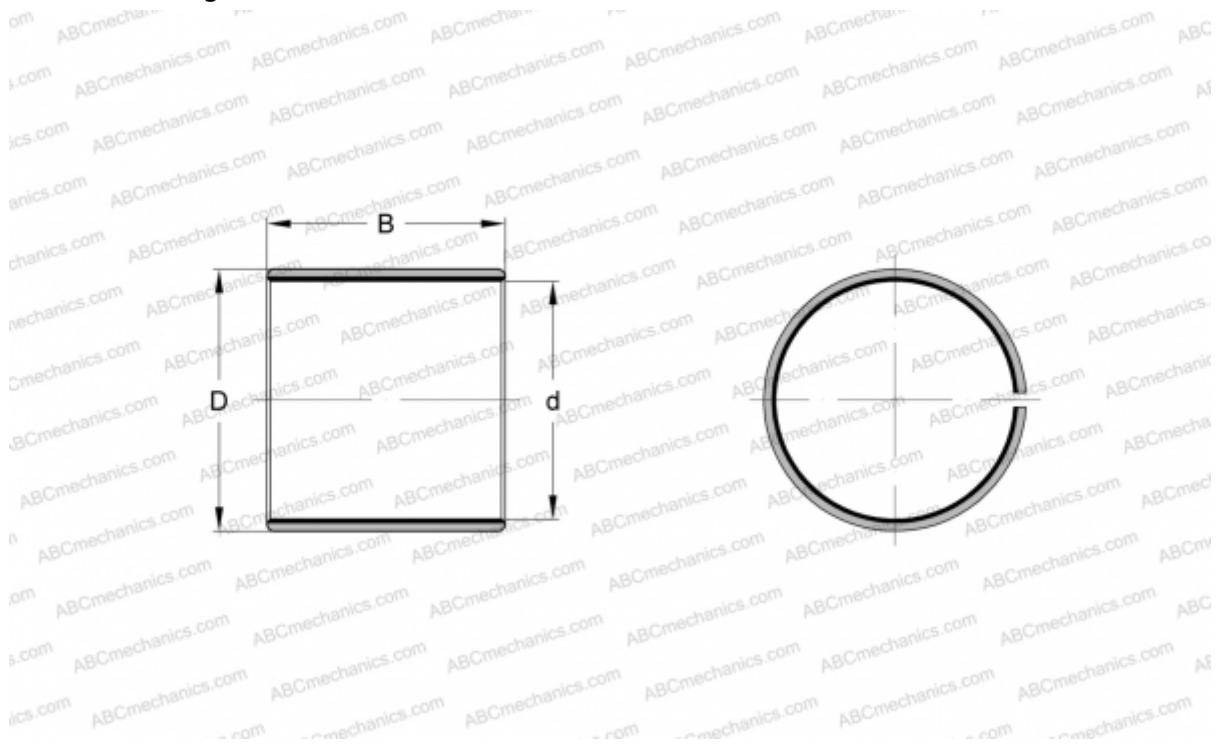

Technical specification

DIMENSIONS, MM

d	20,000
D	23,000
B	15,000

WEIGHT, KG 0,011

MANUFACTURER [INA](#)

REPLACES

PAP2015-P14